

---

**DM 3105**

**Digital Panel Meter**

with two analogue inputs

**Manual**

---



## **Warranty**

For delivered products our "Allgemeine Lieferungs- und Zahlungsbedingungen" are effective. In no event we or our suppliers shall be liable for any other damages whatsoever (including, without limitation, damages for loss of business profits, business interruption or other pecuniary loss) arising out of or inability to use this product.

All our products are warranted against defective material and workmanship for a period of two (2) years from date of delivery. If it is necessary to return the product, the sender is responsible for shipping charges, freight, insurance and proper packaging to prevent breakage in transit. The warranty does not apply to defects resulting from action of the buyer, such as mishandling, improper interfacing, operation outside of design limits, improper repair or unauthorized modification.

## **Trademarks**

All trademarks that are named or portrayed in the text are registered trademarks of its OWNER.

---

# CONTENT

<b>1. Description</b>	<b>4</b>
<b>2. Safety instructions</b>	<b>5</b>
2.1. Symbol explanation	5
<b>3. Mounting</b>	<b>6</b>
3.1. Place of operation	6
3.2. Mounting of digital panel meter	6
3.2.1. Housing for switch board	6
3.2.2. Housing for mosaic Systems	7
<b>4. Electrical connections</b>	<b>8</b>
4.1. General instructions	8
4.2. Hints against noisy environment.	8
4.3. Connection and pin assignment	9
4.4. Connection of input signals	10
4.4.1. Input voltage 0-10 V, Input A	10
4.4.2. Input current 0-20 mA, Input A	10
4.4.3. Input voltage 0-10V or 0-20 mA, Input B	10
4.5. Digital inputs	11
4.6. Connection of alarm output	11
4.7. Connection of accessory power supply output	11
4.8. Connection of analog output.	12
4.9. Connection of power supply voltage.	12
4.9.1. Supply voltage 95 ... 250 V AC	12
4.9.2. Supply voltage 18 ... 36 V DC	12
<b>5. Startup procedur</b>	<b>13</b>
<b>6. Service instruction</b>	<b>14</b>
6.1. Function of buttons and LEDs	14
<b>7. Modes</b>	<b>15</b>
7.1. Operation level.	15
7.2. Access-code level	17
7.3. Programm level	17

<b>8. Procedure of programming</b>	<b>18</b>
8.1. Changing or controlling of the parameters	18
8.2. Overview of the programming levels	19
8.3. Programming level for configuration P-00	20
8.3.1. Scaling the display range	22
8.4. Programming level of linearization P-01	25
8.4.1. 10-point-linearization	<b>26</b>
8.5. Programming level of alarms P-02	27
8.5.1. Alarm functions	28
8.5.2. Alarm high setpoint	30
8.5.3. Alarm low setpoint	30
8.6. Programming level for analog output P-03	31
8.6.1. Scaling of the analog output	31
<b>9. Programming quick reference</b>	<b>32</b>
<b>10. Software functions</b>	<b>34</b>
10.1. MIN/MAX value detection	34
10.2. Averaging	34
10.3. Taring	35
10.4. Display hold	35
10.5. Display test	36
10.6. Main reset	36
<b>11. Technical Specifications</b>	<b>37</b>
11.1. Electrical datas	37
11.2. Mechanical datas	38
11.3. Environmental conditions	38
<b>12. Ordering Information</b>	<b>39</b>

### 1. *Description*

The digital panel meter model DM 3105 is an measuring instrument for two **analog input signals** :

- 2 x Current 0- 20 mA
- **or** 2 x Voltage 0-10 V

#### **Standard hardware components**

- Two relay alarm outputs
- Two programmable digital input channels
- Three programmable push buttons

#### **Standard software functions**

- MAX/MIN value detection
- Auto-Reset of MAX/MIN value
- Average value function
- Tare function
- 10-point linearization
- Manual alarm output reset
- Displaytest and displayhold (latch)

#### **Following options are available**

- Analog output 0 - 10 V, 2 - 10 V, 0 - 20 mA, 4 - 20 mA
- Power supply 18.....36 VDC

### 2. Safety instructions

This instrument is produced in accordance with Class II of IEC 348 and VDE 0411. When delivered the instrument has been tested to meet all functions described. Before installing the instrument please read the mounting and servicing instructions.

We have no liability or responsibility to customer or any other person or entity with respect to any liability, loss or damage caused or alleged to be caused directly or indirectly by equipment or software sold or furnished by us. Read the installation instruction carefully. No liability will be assumed for any damage caused by improper installation.

Inspect the instrument module carton for obvious damage. Be shure there are no shipping and handing damages on the module before processing. Do not apply power to the instrument if it has been damaged.

The warranty does not apply to defects resulting from action of the buyer, such as mishandling, improper interfacing, operation outside of design limits, improper repair or unauthorized modifications.

#### 2.1. Symbol explanation



**Caution**



**Attention**



**Instruction**



**Hint**

**Caution:** Will be used at **dangerous for life and health !**

**Attention:** Will cause **damage**

**Instruction:** If not noticed, **trouble** may occur

**Tip:** Useful hints for **better operation**

### 3. Mounting

#### 3.1. Place of operation

Attention must be paid to the protection against humidity, dust and high temperatures at the place of operation.

#### 3.2. Mounting of digital panel meter

##### 3.2.1. Housing for switch board

- Insert the case into the panel cutout (according to DIN 43700:  $92^{+0,8} \times 45^{+0,6}$  mm)
- Tighten the screws alternately, using enough pressure to get good retention and sealing at the panel.

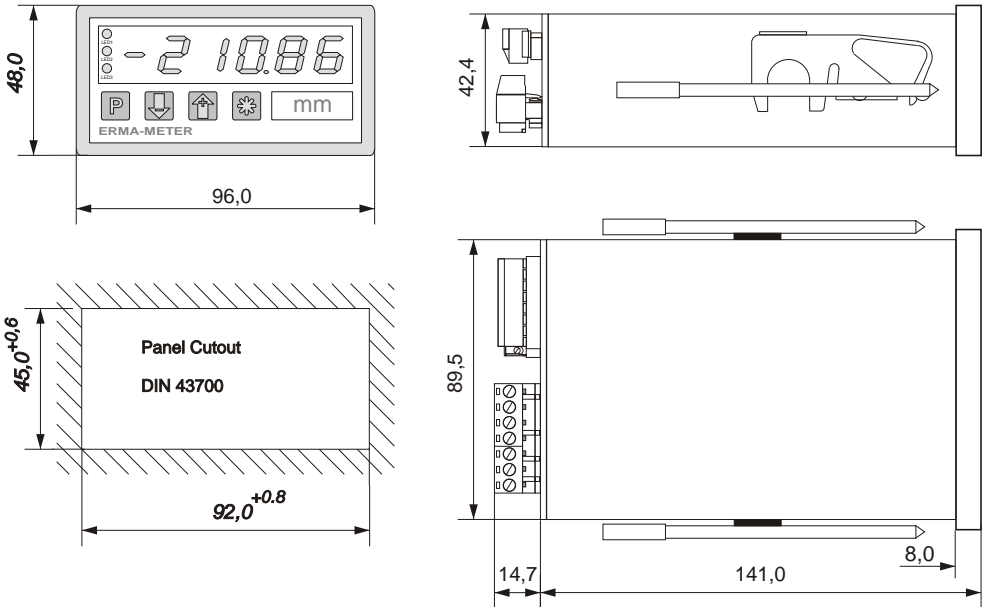

#### 3.2.2. Housing for mosaic Systems

Insert the case in one of the following mosaic-system:

- a) Mosaic system 8RU (M50x25) of Siemens
- b) Mosaic system from Subklev

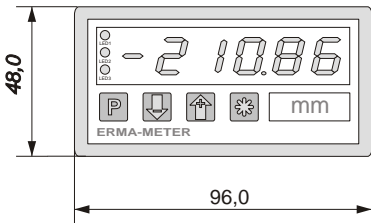

Mosaic-Systems:

Siemens 8RU (M50x25)

Subklev

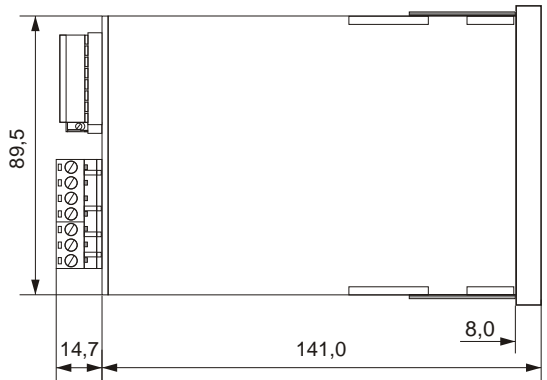
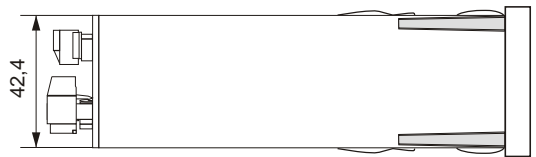



### 4. Electrical connections

#### 4.1. General instructions



- It is forbidden to plug or unplug connectors with voltage applied
- Attach input and output wires to the connectors only without voltages applied
- Cords must be provided with sleeves
- Attention must be paid that the power supply voltage applied will agree with voltage noticed at the name plate.
- The instrument has no power-on switch, so it will be in operation as soon as the power is connected.

#### 4.2. Hints against noisy environment

All inputs and outputs are protected against noisy environment and high voltage spikes. Nevertheless the location should be selected to ensure that no capacitive or inductive interference can have an effect on the instrument or the connection lines.

##### **It is advisable:**



- To use shielded cables.
- The wiring of shields and ground (0V) should be star-shaped.
- The distance to interference sources should be as long as possible. If necessary, protective screen or metal enclosures must be provided.
- Coils of relays must be supplied with filters.
- Parallel wiring of input signals and AC power lines should be avoided.
- Measuring currents, the voltage input should be connected to GND (see also 4.4.2)

### 4.3. Connection and pin assignment

All inputs and outputs are connectors, designed as plug-in screw terminals.

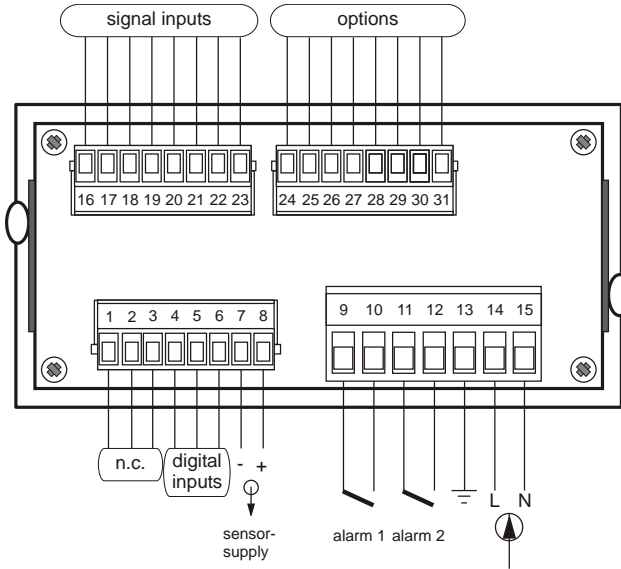

#### Pin assignment:

1	n.c.	16	Signal input A 0-10V
2	n.c.	17	Signal input A 0...20 mA
3	n.c.	18	Signal ground A
4	GND of digital inputs	19	n.c.
5	Digital user input 1	20	n.c.
6	Digital user input 2	21	Signal input B 0-10V or 0...20 mA
7	Accessory power supply output (-)	22	n.c.
8	Accessory power supply output (+)	23	Signal ground B
9/10	Alarm (relay) output 1	24	Option Analogausgang
11/12	Alarm (relay) output 2	bis	
13	Ground connection	31	
14	Power supply L, DC (-)		
15	Power supply N, DC (+)		

### 4.4. Connection of input signals

#### 4.4.1. Input voltage 0-10 V, Input A

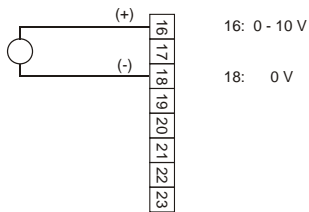

#### 4.4.2. Input current 0-20 mA, Input A

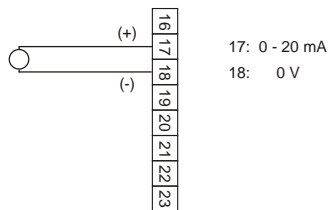

#### 4.4.3. Input voltage 0-10V or 0-20 mA, Input B

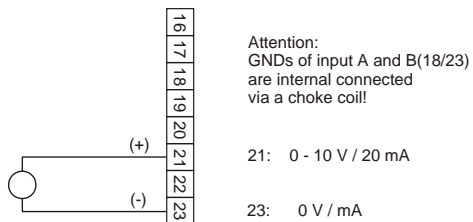

### 4.5. Digital inputs

#### Digital input 1

- active => connecting screw terminal 4 to 5
- connecting to ground, low active

#### Digital input 2

- active => connecting screw terminal 4 to 6
- connecting to ground, low active

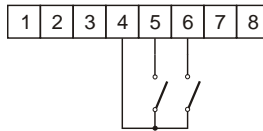

### 4.6. Connection of alarm output

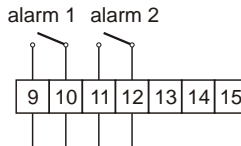

### 4.7. Connection of accessory power supply output

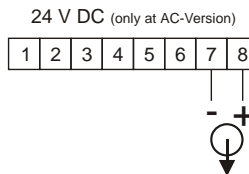

4.8. Connection of analog output

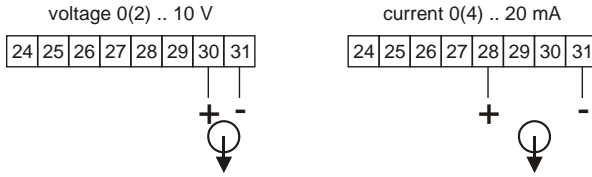

4.9. Connection of power supply voltage

4.9.1. Supply voltage 95 ... 250 V AC

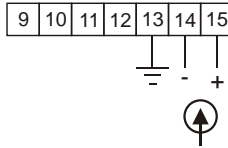

4.9.2. Supply voltage 18 ... 36 V DC

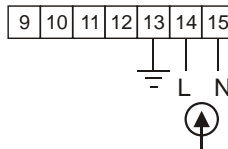

### 5. *Startup procedur*

Attention must be paid that the power supply voltage applied will agree with the voltage noticed at the name plate.

Switch the power supply on (supply voltage applied to 14 and 15). After about 2 seconds the display will indicate the applied input signal.

When delivered, the instrument is programmed with a standard configuration (default configuration). By programming the customer can change the standard configuration according to his measuring task.

**Attention:** When the instrument is built in a machine and the customer wants to change the configuration, attention must be paid, that no damage will occur to the machine!

## 6. Service instruction

There are four push buttons in the front. These push buttons can have different functions. The functions of the push buttons are determined by the used mode of the instrument. By this way the push buttons can be used for programming and for service.

### 6.1. Function of buttons and LEDs

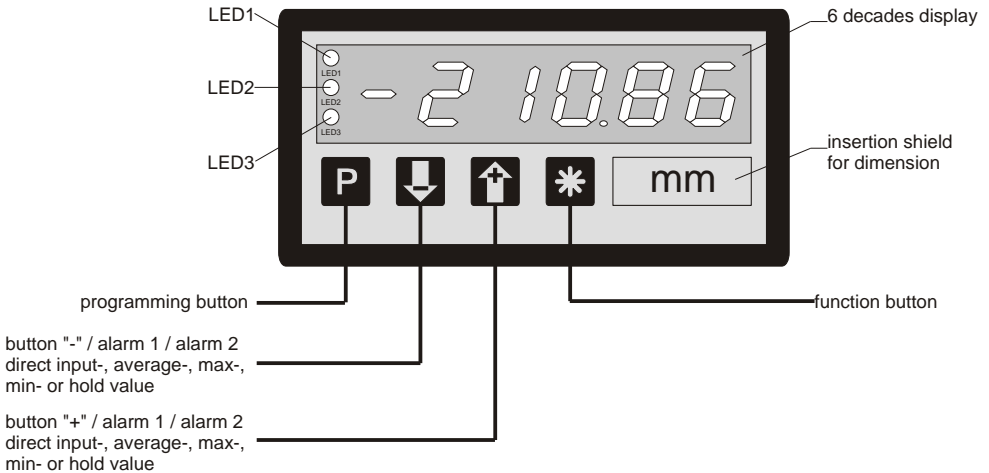

LED 1	LED 2	LED 3	Description
x	x	off	measured-, average- or hold value
x	x	red	MIN value is displayed
x	x	green	MAX value is displayed
x	x	green/blinks	Programming mode is active
x	off	x	alarm 2 is not active
x	lights	x	alarm 2 is active
x	blinks	off	alarm point 2 is displayed
x	blinks	green/blinks	alarm point 2 is changing
off	x	x	alarm 1 is not active
lights	x	x	alarm 1 is active
blinks	x	off	alarm point 1 is displayed
blinks	x	green/blinks	alarm point 1 is changing

x = state of the LED is not considered

## 7. Modes



The operation and the programming of the panel meter is organized in several states:

- Operation level
- Access-code level
- Programm level

### 7.1. Operation level

In the state “operation level” the normal functions of the instrument are activated. A normal measurement cycle looks like below:

- Read measured value, linearization and displaying
- Evaluate the digital inputs; set alarm outputs, set analog output (when available)

Dependent on the programming of the parameter **0-13** (function of key ) , **0-14** (function of key ) and **0-12** (function of key ) , following key-functions are available in the operation level.

Parameter 0-13 Function of pushbutton “*”	 By pressing
0	No function
1	Reset the MIN/MAX value
2	Taring
3	Clear tara value
4	Manual reset of alarms







## 7. Modes

Parameter 0-14 Function of pushbutton “-”		
	By pressing	Pressing during 3 sec.
0	No function	-
1	Display A-B	-
2	Display input A	-
3	Display input B	-
4	Display AVERAGE value	-
5	Display MAX value	-
6	Display MIN value	-
7	Display HOLD value	-
8	Display alarm point 1	Change alarm point 1
9	Display alarm point 2	Change alarm point 2
10	Display input (A-B) / B	-

Parameter 0-15 Function of pushbutton “+”		
	By pressing	Pressing during 3 sec.
0	No function	-
1	Display A-B	-
2	Display input A	-
3	Display input B	-
4	Display AVERAGE value	-
5	Display MAX value	-
6	Display MIN value	-
7	Display HOLD value	-
8	Display alarm point 1	Change alarm point 1
9	Display alarm point 2	Change alarm point 2
10	Display input (A-B) / B	-

### 7.2. Access-code level





The state "access-code level" becomes active by pressing the pushbutton  during the state "operation level". The display shows "c000". During the state "access-code level" the normal functions of the instrument are active.

pushbutton	Function
	Confirm of the displayed access-code
	Increase the access-code
	Decrease the access-code
	Programmed function

### 7.3. Programm level

The state "programm level" becomes active by entering the right access-code. The access-code must be confirmed by pressing the pushbutton . The programming is organized in following steps:



- Selection of a programming level
- Selection of a parameter
- Change of the selected parameter

Pushbutton	Press	Pressing during 3 sec.
	Selection of - Programm level - Parameter	-
	Decrease of - Programm level - Number of parameter - Value of parameter	-
	Increase of - Programm level - Number of parameter - Value of parameter	-
	-	Break the programming routine

### 8. Procedure of programming

The procedure of programming is organized in several different steps.



#### Access to the selection of the programming levels

- Pressing pushbutton **P** => access-code enter is active
- The display shows "c000"
- Changing the access-code by pressing the pushbutton  or  and confirm the changed access-code by pressing the pushbutton **P**



If the entered access-code is not correct, the instrument will jump back to the state "operation level".

### 8.1. Changing or controlling of the parameters



#### Activating the programming routine

- Pressing pushbutton **P**
- LED 3 flashes green
- The display shows "c000"
- Changing the access-code by pressing the pushbutton  or 
- Confirm access-code by pressing the pushbutton **P**
- The display shows "P-00"



#### Leaving the programming routine

- Pressing the pushbutton  or  until the display shows "PEnd"
- Confirm the display "PEnd" by pressing the pushbutton **P**
- LED 3 is off
- The active state of the panel meter is "operation level"



#### Selection of the programming level

- Selecting the programming level by pressing the pushbutton  or 
- Confirm the programming level by pressing the pushbutton **P**
- The display shows the number of the parameter of the selected programming level  
For example: "0-00" => parameter 0 of the programming level 0  
For example: "1-00" => parameter 0 of the programming level 1



### Leaving the programming level

- Pressing the pushbutton  or  until the display shows "xEnd"  
For example: "0End" => leaving programming level 0  
For example: "1End" => leaving programming level 1
- Confirm the display "xEnd" by pressing the pushbutton 
- The display shows the programming level  
For example: "P-00" => for programming level 0  
For example: "P-01" => for programming level 1

### Selection of the parameter

- Selection the parameter by pressing the pushbutton  or 
- Confirm the parameter by pressing the pushbutton 
- The display shows the last programmed value of the selected parameter

### Change and control the selected parameter

- Change the value of the parameter by pressing the pushbutton  or 
- Confirm the value of the parameter by pressing the pushbutton 

The display shows the programming level and the number of the parameter

For example: "0-05" => parameter number 5 of programming level 0

For example: "1-08" => parameter number 8 of programming level 1

## 8.2. Overview of the programming levels

The parameters of the panel meter are organized in different programming levels. According to the execution of the panel meter there are several programming levels available.

### **P-00: Programming level to configuration the panel meter**

The configuration is used to adapt the strain gauge bridge sensor to the panel meter.

### **P-01: Programming level of 10 point linearization**

This programming level is used to program the values for the linearization.

### **P-02: Programming level of alarm output function**

This programming level is used to program all settings of the alarm outputs.

### **P-03: Programming level of the analog output**

This programming level is used to program all settings of the analog output..

## 8.3. Programming level for configuration P-00

Param.	Description	Setting range	Default values
0-00	Calibration 0 -> Without calibrator 1 -> With calibrator	0 .. 1	0
0-01	Display value of the minimum input signal A	-99999 .. +99999	0
0-02	Display value of the maximum input signal A	-99999 .. +99999	+10000 or +20000
0-03	Display value of the minimum input signal B	-99999 .. +99999	0
0-04	Display value of the maximum input signal B	-99999 .. +99999	+10000 or +20000
0-05	Programmable points 0 -> XXXXXX 1 -> XXXXX.X 2 -> XXXX.XX 3 -> XXX.XXX 4 -> XX.XXXX	0 .. 4	0
0-06	Filtering 1 -> No averaging X -> Number of averaging cycles	1 .. 255	1
0-07	Data source of the display 0 -> Direct measured values A-B 1 -> Direct measured value A 2 -> Direct measured value B 3 -> AVERAGE value 4 -> MAX value 5 -> MIN value 6 -> HOLD value 7 -> Input (A-B) / B*100 8 -> Input (A-B) / B*100.0 9 -> Input (A-B) / B*100.00	0 .. 9	0
0-08	Data source of MAX-, MIN- and hold value 0 -> Direct measured value 1 -> Averaging value	0 .. 1	0
0-09	Configuration of digit 1 0 -> Display in steps of 1 1 -> Display in steps of 2 2 -> Display in steps of 5 3 -> Display in steps of 10	0 .. 3	0

## 8. Procedure of programming

Param.	Description	Setting range	Default values
0-10	Reset time of the MAX/MIN value 0 -> No automatically reset X -> Reset time in seconds	0 .. 100	0
0-10	Function of digital input 1 0 -> No function 1 -> Reset max.-, min.-value 2 -> Taring 3 -> Clear tara value 4 -> Manual reset of alarms 5 -> Hold function 6 -> Display test 7 -> Display measured input value 0-07 = 7 → (A-B) / B*100 0-07 = 8 → (A-B) / B*100.0 0-07 = 9 → (A-B) / B*100.00 0-07 <> 7,8 or 9 → A-B 8 -> Display input A 9 -> Display input B 10 -> Display maximum value 11 -> Display minimum value	0 .. 11	0
0-12	Function of digital input 2 0 -> No function 1 -> Reset max.-, min.-value 2 -> Taring 3 -> Clear tara value 4 -> Manual reset of alarms 5 -> Hold function 6 -> Display test 7 -> Display measured input value 0-07 = 7 → (A-B) / B*100 0-07 = 8 → (A-B) / B*100.0 0-07 = 9 → (A-B) / B*100.00 0-07 <> 7,8 or 9 → A-B 8 -> Display input A 9 -> Display input B 10 -> Display maximum value 11 -> Display minimum value	0 .. 11	0
0-13	Function of pushbutton "*" 0 -> No function 1 -> Reset MAX/MIN value 2 -> Taring 3 -> Clear tara value 4 -> Manual reset of alarm	0 .. 4	0

## 8. Procedure of programming

Param.	Description	Setting range	Default values
0-14	Function of pushbutton “-” 0 -> No function 1 -> Display A-B Display measured input value 0-07 = 7 → (A-B) / B*100 0-07 = 8 → (A-B) / B*100.0 0-07 = 9 → (A-B) / B*100.00 0-07 <> 7,8 or 9 → A-B 2 -> Display input A 3 -> Display input B 4 -> Display AVERAGE value 5 -> Display MAX value 6 -> Display MIN value 7 -> Display HOLD value 8 -> Display/edit alarm point 1	0 .. 9	0
0-15	Function of pushbutton “+” 0 -> No function 1 -> Display A-B Display measured input value 0-07 = 7 → (A-B) / B*100 0-07 = 8 → (A-B) / B*100.0 0-07 = 9 → (A-B) / B*100.00 0-07 <> 7,8 or 9 → A-B 2 -> Display input A 3 -> Display input B 4 -> Display AVERAGE value 5 -> Display MAX value 6 -> Display MIN value 7 -> Display HOLD value 8 -> Display/edit alarm point 1 9 -> Display/edit alarm point 2	0 .. 9	0
0-16	Access-code	0 .. 999	0
0End	Leaving programming level 0		

### 8.3.1. Scaling the display range

The measuring ranges for the signal inputs A and B are calibrated at factory to the following presettings: 0 to 10 V displays 0 to 10000. (resp. 0 to 20 mA displays 20000). It is no further calibration needed to put the device into operation.

There are two possibilities to assign the display range to the input signal:

- Calibration without a calibrator
- Calibration with a calibrator

### Calibration without a calibrator

The assignment of the display range to the minimal and maximal input signal is done by programming the parameter 0-02 and 0-03.

**The parameter 0-01 must be programmed to 0**

#### Example:

Input range:  $\pm 10\text{ V}$

Display range:  $\pm 20000$

Step	Param.	Range
1.	0-00	0
2.	0-01	0
3.	0-02	-20000
4.	0-03	20000
5.	0End	End

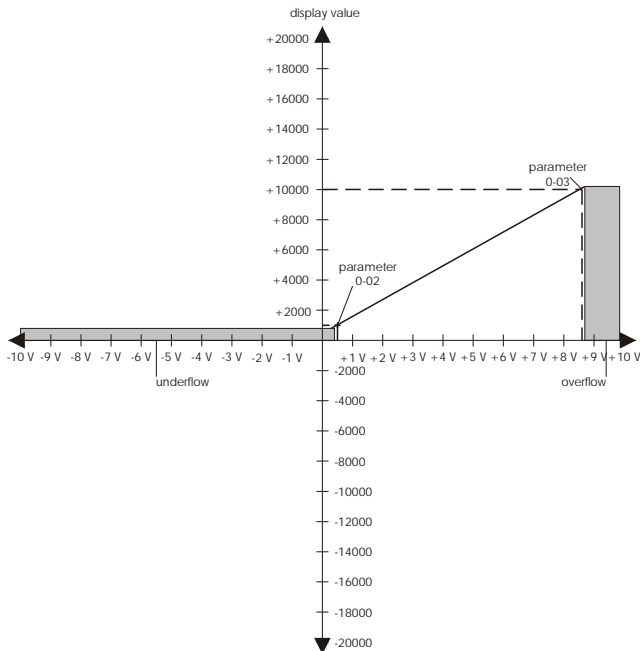



### Calibration with calibrator

The assignment of the display range to the minimal and maximal input signal is done by programming the parameter 0-02 and 0-03. The minimal and maximal input signal must be connected direct to the panel meter when programming the parameter 0-02 or 0-03.

**The parameter 0-01 must be programmed to 1.**



**Attention: By the calibration with a calibrator the factory settings of the adjustment values are changed. Make use of this possibility only with a suitable calibrator. The factor settings of the adjustment values are changed as soon as displaying the value of the parameter 0-02 or 0-03.**

#### Example:

Input signal range: +0,5 V to +8,6 V

Display range: +1000 to +10000

step	param.	procedure	range
1.	0-00	set the parameter to 0-00	0
2.	0-01	-	1
3.	-	connecting 0,5 V to the signal input	-
4.	0-02	-	1000
5.	-	connecting 8,6 V to the signal input	-
6.	0-03	-	10000
7.	0End	-	end

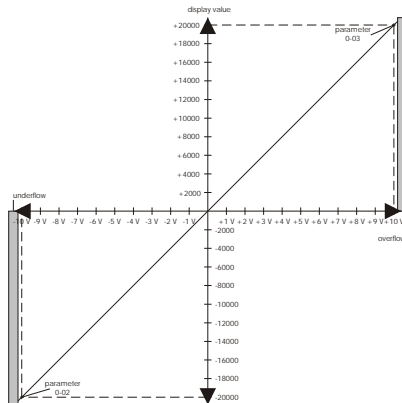

## 8.4. Programming level of linearization P-01

Param.	Description	Setting range	Default values
1-00	Number of linearization points	2 .. 10	2
1-01	Linearization point 1 Input value	± max. prog. display range	0
1-02	Linearization point 1 Output value	± max. prog. display range	0
1-03	Linearization point 2 Input value	± max. prog. display range	+10000 or +20000
1-04	Linearization point 2 Output value	± max. prog. display range	+10000 or +20000
1-05	Linearization point 3 Input value	± max. prog. display range	0
1-06	Linearization point 3 Output value	± max. prog. display range	0
1-07	Linearization point 4 Input value	± max. prog. display range	0
1-08	Linearization point 4 Output value	± max. prog. display range	0
1-09	Linearization point 5 Input value	± max. prog. display range	0
1-10	Linearization point 5 Output value	± max. prog. display range	0
1-11	Linearization point 6 Input value	± max. prog. display range	0
1-12	Linearization point 6 Output value	± max. prog. display range	0
1-13	Linearization point 7 Input value	± max. prog. display range	0
1-14	Linearization point 7 Output value	± max. prog. display range	0

## 8. Procedure of programming

Param.	Description	Setting range	Default values
1-15	Linearization point 8 Input value	$\pm$ max. prog. display range	0
1-16	Linearization point 8 Output value	$\pm$ max. prog. display range	0
1-17	Linearization point 9 Input value	$\pm$ max. prog. display range	0
1-18	Linearization point 9 Output value	$\pm$ max. prog. display range	0
1-19	Linearization point 10 Input value	$\pm$ max. prog. display range	0
1-20	Linearization point 10 Output value	$\pm$ max. prog. display range	0
1End	Leave programming level P-01		

### 8.4.1. 10-point-linearization

The panel meter include the possibility of a linearization up to 10 points.

#### Linearization of the input signal

- only for the input range 0 to 2 (current or voltage) possible
- not for RTD or thermal junction
- only in the programmed display range possible (parameter 0-02 and 0-03)

#### Performing a linearization

- Insert the number of linearization points (parameter 1-00)
- For each point must be programmed two values, the input value and the corresponding output value
- If leaving the programming routine, the linearization points will sort in rising sequence

#### Reset the linearization points by

- Changing the parameter 0-02 or 0-03
- Changing the input range (parameter 0-00)

#### Reset the linearization points to

- Number of linearization points = 2 (parameter 1-00)
- Linearization point 1 = parameter 0-02
- Linearization point 2 = parameter 0-03



The linearization is done after the calculation of input A and input B. Therefore it is not possible to make a linearization of the single inputs A and B. Only the results of the formulas A-B or  $(A-B) / B$  can be linearized.

### 8.5. Programming level of alarms P-02

Param.	Description	Setting range	Default values
2-00	Alarm output 1, data source 0 -> Alarm 1 off 1 -> Alarm 1 to direct measured value 0-07 = 7 → $(A-B) / B * 100$ 0-07 = 8 → $(A-B) / B * 100.0$ 0-07 = 9 → $(A-B) / B * 100.00$ 0-07 <> 7,8 or 9 → A-B 2 -> Alarm 1 to average value 3 -> Alarm 1 to maximum value 4 -> Alarm 1 to minimum value 5 -> Alarm 1 to hold value	0 .. 5	0
2-01	Alarm output 1, high or low 0 -> Contact closed by low limit 1 -> Contact closed by high limit 2 -> Contact open by low limit 3 -> Contact open by high limit	0 .. 3	0
2-02	Alarm output 1, alarm point	± max. prog. display range	10000 or 20000
2-03	Alarm output 1, hysteresis	1 .. 1000	1
2-04	Alarm output 1, release delay time in seconds	0 .. 60	0
2-05	Alarm output 1, operate delay time in seconds	0 .. 60	0

## 8. Procedure of programming

Param.	Description	Setting range	Default values
2-06	Alarm output 2, data source 0 -> Alarm 2, off 1 -> Alarm 2 to direct measured value 0-07 = 7 → (A-B) / B*100 0-07 = 8 → (A-B) / B*100.0 0-07 = 9 → (A-B) / B*100.00 0-07 <> 7,8 or 9 → A-B 2 -> Alarm 2 to average value 3 -> Alarm 2 to maximum value 4 -> Alarm 2 to minimum value 5 -> Alarm 2 to hold value	0 .. 5	0
2-07	Alarm output 2, high or low 0 -> Contact closed by low limit 1 -> Contact closed by high limit 2 -> Contact open by low limit 3 -> Contact open by high limit	0 .. 3	0
2-08	Alarm output 2, alarm point	± max.prog. display range	10000 or 20000
2-09	Alarm output 2, hysteresis	1 .. 1000	1
2-10	Alarm output 2, release delay time in seconds	0 .. 60	0
2-11	Alarm output 2, operate delay time in seconds	0 .. 60	0
2End	Leave programming level P-02		

### 8.5.1. Alarm functions

#### Data sources of the alarms:

- Direct measured value ( A-B or (A-B)/B ; depending on the value of P0-07)
- Average value
- Maximum value
- Minimum value
- Hold value

#### Indication of alarms

- Two relay output
- LED 1 and LED 2 at the front

#### Reset the alarms by:

- Changing the parameter 0-01/0-02 or 0-03/0-04

### Reset the alarms to:

- Alarm value = parameter 0-02
- The alarms are switched off



### Programmable functions of the alarms

- Alarm value
- Hysteresis
- Release delay time and operate delay time
- High or low alarm

### Manual alarm reset

In dependence of programming the digital inputs and the functional pushbutton  is the alarm output latched or not latched.

Alarm output latched:



- If the digital input 1, 2 (parameter 0-10 and 0-11) or the functional pushbutton  (parameter 0-13) is programmed to manual alarm reset
- Reset the latched alarm output by activate the digital inputs or press the functional pushbutton 

Alarm output not latched:

- If the digital inputs and the functional pushbutton  are not programmed to manual alarm reset

### Display and edit the alarm values

The alarm points can displayed and edited on different kinds.

- Inside the programmig routine, which is reached over the enter code. During the programming routine no measurement is taken.
- Outside the programming routine by pressing the pushbutton  or  during normal measurement are taken.

The changed alarm value(s) are confirmed by pressing the pushbutton  .  
(ref. to 7.1 Operation level)

### 8.5.2. Alarm high setpoint

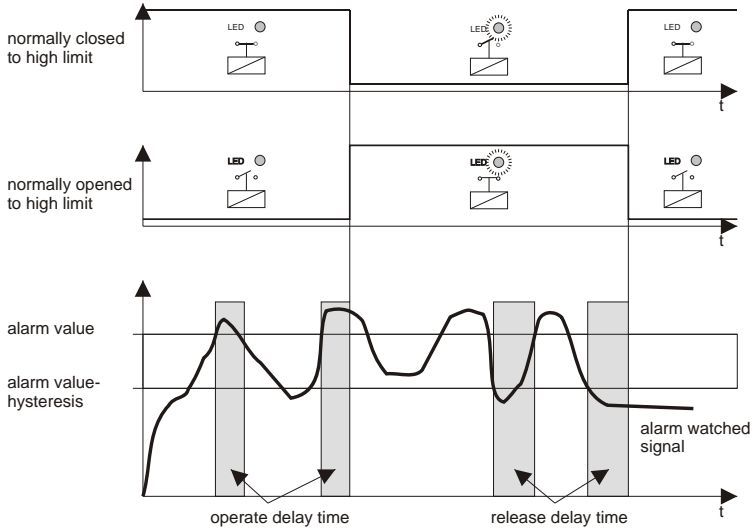

### 8.5.3. Alarm low setpoint

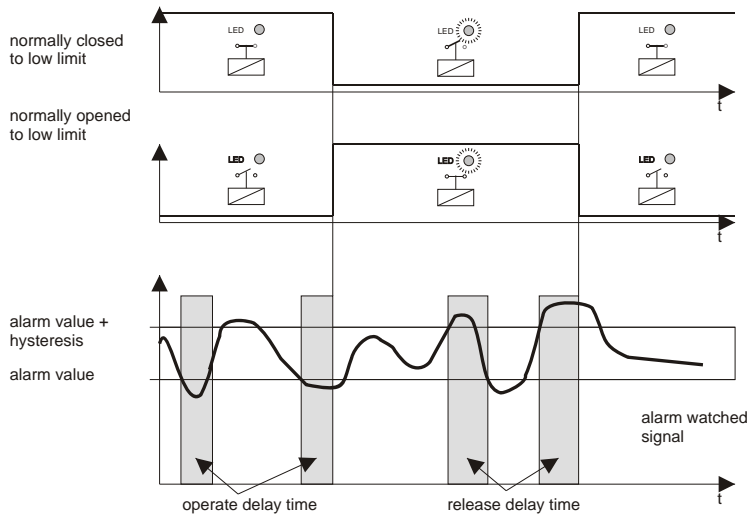

### 8.6. Programming level for analog output P-03

The programming level P-03 is only available with the option analog output.

Param.	Description	Range	Default Value
3-00	Analog Output, data source 0 -> Direct measured value to analog output 0-07 = 7 → (A-B) / B*100 0-07 = 8 → (A-B) / B*100.0 0-07 = 9 → (A-B) / B*100.00 0-07 <> 7,8 or 9 → A-B 1 -> Average value to analog output 2 -> Maximum value to analog output 3 -> Minimum value to analog output 4 -> Hold value to analog output	0 .. 4	0
3-01	Analog Output, configuration 0 -> 0 to 10 V 1 -> 2 to 10 V 2 -> 0 to 20 mA 3 -> 4 to 20 mA	0 .. 3	0
3-02	Display value for min. analog output signal	± max. prog. display range	0
3-03	Display value for max. analog output signal	± max. prog. display range	10000 or 20000
3End	Leave programming level P-03		

#### 8.6.1. Scaling of the analog output

The scaling of the analog output range can be programmed with the parameter 3-02 and 3-03. Any value in the configured scale (parameter 0-02 and 0-03) can be set to minimal and maximal analog output signal.

##### Data sources of the analog output:

- Direct measured input ( A-B or (A-B)/B ; depending on the value of P0-07
- Average value
- Minimum/Maximum value or Hold value

##### Reset the scaling of the analog output range by:

- Changing the Parameter 0-01/0-02 or 0-03/0-04

##### Reset the scaling of the analog output range to:

- Changing the parameter 3-02 to the value of parameter 0-01
- Changing the parameter 3-03 to the value of parameter 0-02



9. Programming quick reference

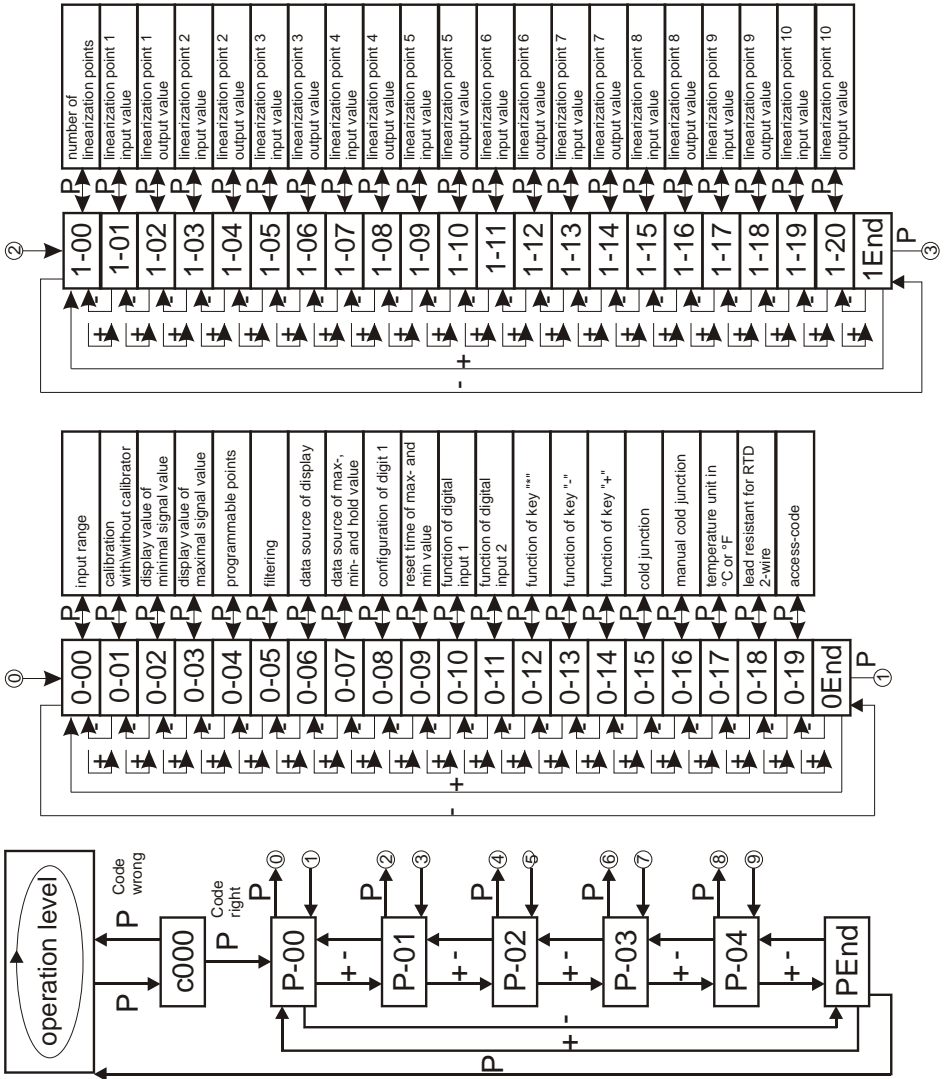

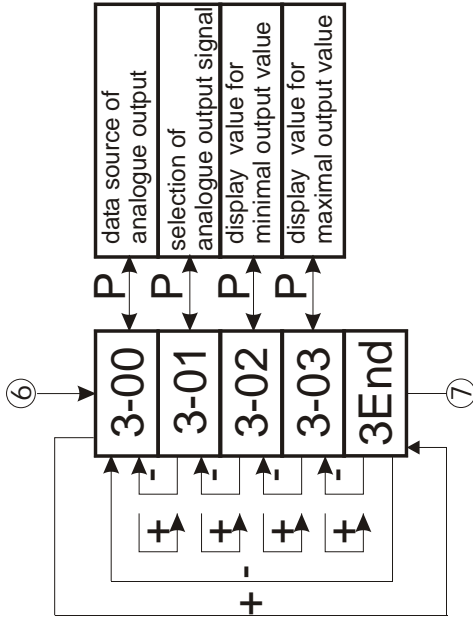

discription	
P	→ pressing the button
+	→ pressing the button
-	→ pressing the button

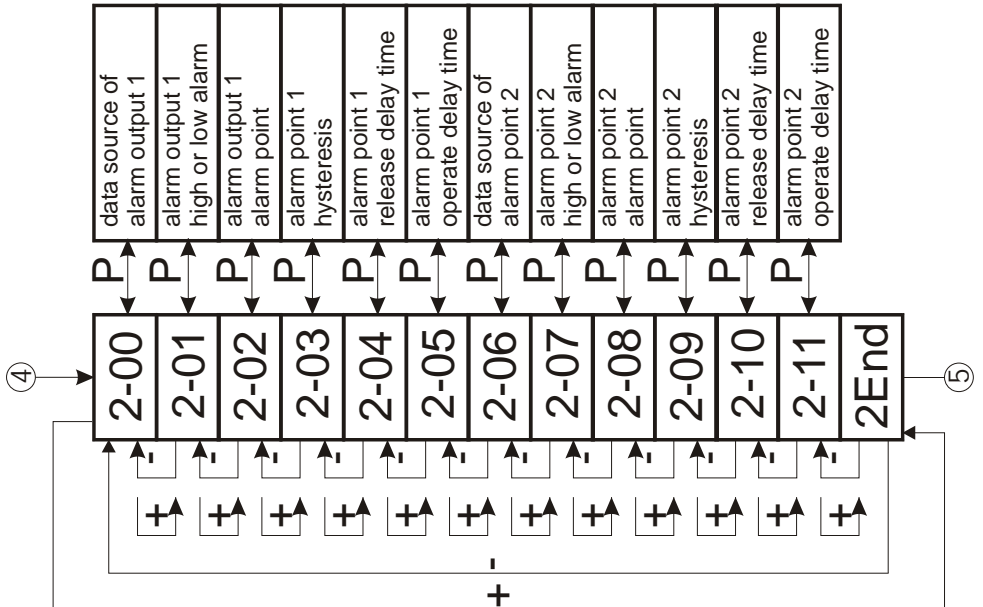

## 10. Software functions



### 10.1. MIN/MAX value detection

The panel meter include a MIN/MAX value detection. The maximum and minimum value can be displayed with the frontal push buttons or the digital user inputs. Besides the maximum and minimum value can be controlled of the alarm output or can be used as the data source for the analog output.

#### Reset the maximum and minimum values:

- Automatically by the programmed memory reset time (parameter 0-09)
- By activating the digital inputs 1 or 2 (parameter 0-10 and 0-11)
- By pressing the functional pushbutton  (parameter 0-12)
- By leaving the programming routine

#### Display the maximum and minimum value

- By programming as data source of the display (parameter 0-06)
- By activating the digital input 1 or 2 (parameter 0-10 and 0-11)
- By pressing the pushbutton  or  (parameter 0-13 and 0-14)

#### Indication of the displayed maximum and minimum value

- LED 3 lights green => maximum value is displayed
- LED 3 lights red => minimum value is displayed

### 10.2. Averaging

The panel meter include a programmable single pole digital filter. The filter is used to smooth analog input data in noisy environments.

Digital filtering is performed by forming the average of input signals. By a special algorithm it is provided that a smooth filtering will be achieved.

$$\text{time constant} = \frac{\text{number of measurements}}{\text{measuring rate}}$$

If the input signal is a step function, 99,3 % of the final measurement value will be reached within 5 time constants.

### 10.3. Taring

By activating the tara function, the direct input value will be taken over into the tara memory. The tara value is being subtract from the direct input value and effect of the direct input value and the mean value.

#### Activating the tara function by:

- The digital input 1 (parameter 0-10)
- The digital input 2 (parameter 0-11)
- The functional pushbutton  (parameter 0-12)

#### Clear the tara value by:

- Activating the digital input 1 (parameter 0-10)
- Activating the digital input 2 (parameter 0-11)
- Pressing the functional pushbutton  (parameter 0-12)

#### Reset the tara value by:

- Changing the parameter 0-02 or 0-03
- Changing the input range (parameter 0-00)

### 10.4. Display hold

When activating the hold function the value of the data source, which is programmed in parameter 0-07 is taken over into the hold memory. If the hold function is not active the hold value is the same as the value of the data source, which is programmed in parameter 0-07.



#### Activating the hold function by:

- Digital input 1 (parameter 0-10)
- Digital input 2 (parameter 0-11)

#### Reset the hold value

- By leaving the programming routine

#### Display the hold value by

- Programming as data source of the display (parameter 0-06)
- Pressing the pushbutton  or  (parameter 0-13 and 0-14)

#### The hold value can:

- Show on display
- Watched by alarm output
- Set to the analog output

### 10.5. Display test

When activating the display test all segments of the display are light on. The display shows "8.8.8.8.8.8."

**Activating the display test by:**

- Digital input 1 (parameter 0-10)
- Digital input 2 (parameter 0-11)

### 10.6. Main reset

The main reset is performed by pressing a key combination at the front of the panel meter. By doing this all parameters are setting to the default value. The value of the parameter 0-00 (input range) is not changing by the main reset. During the main reset the display shows "Init."

**Perform the main reset by**

Pressing the pushbuttons  ,  and  at the same time during 10 seconds.

## 11. Technical Specifications

### 11.1. Electrical datas

#### Input ranges

voltage	: 0 - 10 V, $\pm 0,01$ %, $\pm 1$ Digit
impedance	: 1 M
current	: 0 - 20 mA, $\pm 0,01$ %, $\pm 1$ Digit
impedance	: 10

#### Resolution of the A/D-Converter

: 16 Bit

#### Conversion rate

: 5/s

#### Alarm outputs

: 2 relays (programmable as opened contact or closed contact)

Signaling	: 2 LEDs at the front
Switch voltage	: 250 V AC / 250 V DC
Switch current	: 5 A AC / 5 A DC
Switch power	: 750 VA / 100 W

#### Digital user inputs

: 10 k to +5 V  
 : NPN, max. 30 V  
 : L-Pegel < 0,4 V  
 : H-Pegel > 3,5 V

#### Option analog output

: resolution 16 bit  
 :  $\pm 0,2$  % of final value  
 : 0/2 - 10 V, max. 10 mA  
 : 0/4 - 20 mA, max. 500  
 : 3 kV / 1 min

#### Power supply AC

: 95 .. 250 V AC  
 Power consumption : approx. 9 VA  
 Isolation voltage : 2,5 kV / 1 min

#### Option power supply DC

: 18 .. 36 V DC  
 Power consumption : approx. 70 mA  
 Isolation voltage : 500 V / 1 min

#### Accessory power supply (only at AC)

: 24 V DC  $\pm 10$  %, max. 125 mA  
 Isolation voltage : 500 V / 1 min

### 11.2. Mechanical datas

<b>Display</b>	: 6 decades, 14 mm, red : decimal point programmable : preliminary zero suppression : - sign at negative values
<b>Operation, keyboard design</b>	: front membrane with push buttons
<b>Case</b>	: switch board mounting DIN 43 700
Dimensions (B x H x T)	: 96 x 48 x 141 mm
Depth	: 148 mm incl. screw terminal
Mounting	: switch board mounting or : mosaic-system mounting
<b>Weight</b>	: approx. 400 g
<b>Connection</b>	: plug-in screw terminal
Signal inputs	: max. □ 1,5 mm <sup>2</sup>
Alarm outputs	: max. □ 2,5 mm <sup>2</sup>
Power inputs	: max. □ 2,5 mm <sup>2</sup>

### 11.3. Environmental conditions

Operating temperature	: 0 .. 50 °C
Storage temperature	: -20 .. 70 °C
Humidity	: < 80 %, not-condensing
Protection	: protection class II
Front protection	: IP 54
Field of application	: connectors IP 20 : class 2 : overvoltage protection II
CE	: in conform with 89/336/EWG : NSR 73/23/EWG

## 12. Ordering Information

DM 3105-		0						
								<b>Analogue inputs</b>
								<b>0</b> 0 - 10 V
								<b>1</b> 0 - 20 mA
								<b>Housing</b>
								<b>0</b> switch board mounting
								<b>1</b> panel clip mounting
								<b>Front frame color</b>
								<b>0</b> black
								<b>Front design</b>
								<b>1</b> no logo
								<b>2</b> customer defined logo
								<b>Power supply</b>
								<b>0</b> 95...250 VAC
								<b>1</b> 18...36 VDC
								<b>Option analogue output</b>
								<b>0</b> no analogue output
								<b>1</b> with analogue output









ERMA - Electronic GmbH  
Max-Eyth-Str. 8  
D-78194 Immendingen

Telefon (+49 7462) 2000-0  
Fax (+49 7462) 2000-29  
email [info@erma-electronic.com](mailto:info@erma-electronic.com)  
Web [www.erma-electronic.com](http://www.erma-electronic.com)

