DM 2400

Digital Panel Meter

for Analog Input Signal

Instruction Manual



ERMA

Electronic GmbH

Warranty

For delivered products our "Allgemeine Lieferungs- und Zahlungsbedingungen" are effective. In no event we or our suppliers shall be liable for any other damages whatsoever (including, without limitation, damages for loss of business profits, business interruption or other pecuniary loss) arising out of or inability to use this product.

All our products are warranted against defective material and workmanship for a period of two (2) years from date of delivery. If it is necessary to return the product, the sender is responsible for shipping charges, freight, insurance and proper packaging to prevent breakage in transit. The warranty does not apply to defects resulting from action of the buyer, such as mishandling, improper interfacing, operation outside of design limits, improper repair or unauthorized modification.

Trademarks

All trademarks that are named or portrayed in the text are registered trademarks of its owner.

CONTENTS

| | |
|--|-----------|
| 1. Description | 4 |
| 2. Safety instructions | 5 |
| 2.1. Symbol explanation | 5 |
| 3. Mounting | 6 |
| 3.1. Place of operation | 6 |
| 3.2. Mounting of digital panel meter | 6 |
| 4. Electrical connections | 7 |
| 4.1. General instructions | 7 |
| 4.2. Hints against noisy environment. | 7 |
| 4.3. Connection and pin assignment. | 8 |
| 4.4. Connection of input signals | 9 |
| 4.4.1. Input voltage ± 10 V, 0 - 10 V | 9 |
| 4.4.2. Input current ± 20 mA, 4 - 20 mA, 0 - 20 mA | 9 |
| 4.4.3. RTD 2-wire. | 9 |
| 4.4.4. RTD 4-wire. | 9 |
| 4.4.5. Thermocouple | 10 |
| 4.5. Connection of alarm output | 10 |
| 4.6. Connection of power supply voltage. | 10 |
| 4.6.1. Supply voltage 18 ... 36 V DC | 10 |
| 5. Startup procedur | 10 |
| 6. Service instruction | 11 |
| 6.1. Function of buttons and LEDs | 11 |
| 7. Modes | 12 |
| 7.1. Operation level. | 12 |
| 7.2. Access-code level | 13 |
| 7.3. Programm level | 14 |
| 8. Procedure of programming | 15 |
| 8.1. Changing or controlling of the parameters | 15 |
| 8.2. Overview of the programming levels | 16 |
| 8.3. Programming level for configuration P-00. | 17 |

| | | |
|------------|---|-----------|
| 8.3.1. | Scaling the display range | 20 |
| 8.4. | Programming level of linearization P-01 | 22 |
| 8.4.1. | 10-point-linearization | 23 |
| 8.5. | Programming level of alarms P-02 | 24 |
| 8.5.1. | Alarm functions | 25 |
| 8.5.2. | Alarm high setpoint | 27 |
| 8.5.3. | Alarm low setpoint | 27 |
| 8.6. | Programming quick reference | 28 |
| 9. | Software functions | 30 |
| 9.1. | MIN/MAX value detection | 30 |
| 9.2. | Averaging | 30 |
| 9.3. | Taring | 31 |
| 9.4. | Display hold | 31 |
| 9.5. | Display test | 32 |
| 9.6. | Main reset | 32 |
| 10. | Cold junction | 32 |
| 11. | RTD Lead Resistance Adjustment | 32 |
| 12. | Error codes | 33 |
| 12.1. | Sensor break detection | 33 |
| 13. | Technical Specifications | 34 |
| 13.1. | Electrical datas. | 34 |
| 13.2. | Mechanical datas | 35 |
| 13.3. | Environmental conditions | 35 |
| 14. | Ordering Information | 36 |
| 15. | Notes | 37 |

1. *Description*

The digital panel meter model **DM 2400** is an universal instrument for measuring **analog input signals** listed below:

- Voltage ± 10 V, 0 - 10 V
- Current ± 20 mA / 4 - 20 mA, 0 - 20 mA
- RTD 2-Wire / 4-Wire
- Thermocouple type K, J, L, S, T, U, R

Standard hardware components

- Two relay alarm outputs
- Two programmable push buttons

Standard software functions

- MAX/MIN value detection
- Auto-Reset of MAX/MIN value
- Average value function
- Tare function
- 10-point linearization
- Manual alarm output reset
- Displaytest and displayhold (latch)

2. Safety instructions

This instrument is produced in accordance with Class II of IEC 348 and VDE 0411. When delivered the instrument has been tested to meet all functions described. Before installing the instrument please read the mounting and servicing instructions.

We have no liability or responsibility to customer or any other person or entity with respect to any liability, loss or damage caused or alleged to be caused directly or indirectly by equipment or software sold or furnished by us. Read the installation instruction carefully. No liability will be assumed for any damage caused by improper installation.

Inspect the instrument module carton for obvious damage. Be shure there are no shipping and handing damages on the module before processing. Do not apply power to the instrument if it has been damaged.

ERMA's warranty does not apply to defects resulting from action of the buyer, such as mishandling, improper interfacing, operation outside of design limits, improper repair or unauthorized modifications.

2.1. Symbol explanation



Caution



Attention



Instruction



Hint

Caution: Will be used at **dangerous for life and health !**

Attention: Will cause **damage**

Instruction: If not noticed, **trouble** may occur

Hint: Useful hints for **better operation**

3. Mounting

3.1. Place of operation

Attention must be paid to the protection against humidity, dust and high temperatures at the place of operation.

3.2. Mounting of digital panel meter

- Insert the case into the panel cutout (according to DIN 43700: $45^{+0,6} \times 45^{+0,6}$ mm)
- Tighten the screws alternately, using enough pressure to get good retention and sealing at the panel.

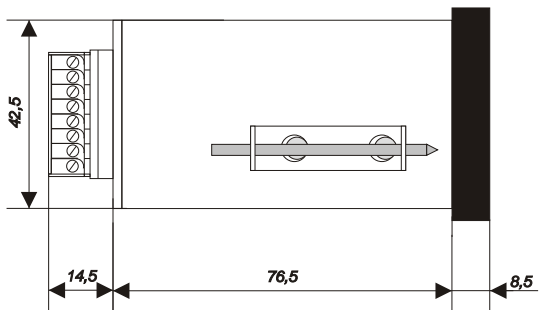
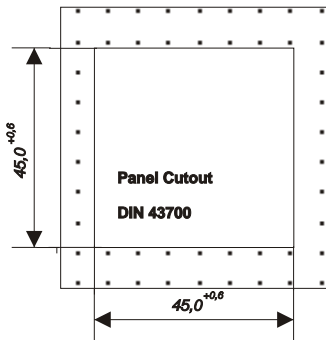
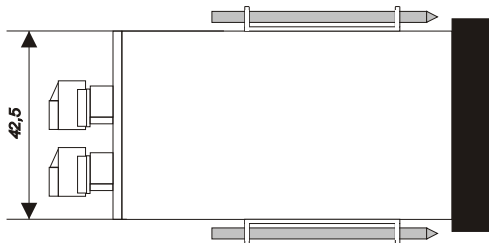
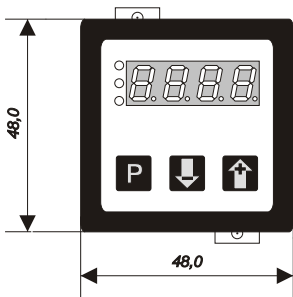

4. Electrical connections

4.1. General instructions



- It is forbidden to plug or unplug connectors with voltage applied
- Attach input and output wires to the connectors only without voltages applied
- Cords must be provided with sleeves
- Attention must be paid that the power supply voltage applied will agree with voltage noticed at the name plate.
- The instrument has no power-on switch, so it will be in operation as soon as the power is connected.

4.2. Hints against noisy environment

All inputs and outputs are protected against noisy environment and high voltage spikes. Nevertheless the location should be selected to ensure that no capacitive or inductive interference can have an effect on the instrument or the connection lines.

It is advisable:

- To use shielded cables.
- The wiring of shields and ground (0V) should be star-shaped.
- The distance to interference sources should be as long as possible. If necessary, protective screen or metal enclosures must be provided.
- Coils of relays must be supplied with filters.
- Parallel wiring of input signals and AC power lines should be avoided.
- Measuring currents, the voltage input should be connected to GND (see also 4.4.2)

4.3. Connection and pin assignment

All inputs and outputs are connectors, designed as plug-in screw terminals.

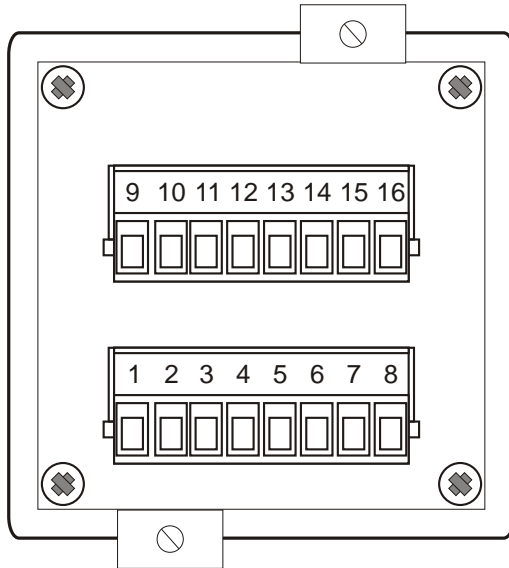

Pin assignment:

| | | | |
|---|---------------------------------------|-------|---------------------------|
| 1 | Input 10 V / Pt100 (+) | 9/10 | Alarm 1 (relay), Contacts |
| 2 | Input Thermocouple | 11/12 | Alarm 2 (relay), Contacts |
| 3 | Input 20 mA | 13 | n.c. |
| 4 | Input GND/ Pt100-Constant Current (-) | 14 | Ground Connection |
| 5 | Input Pt 100 (-) | 15 | Power Supply DC (-) |
| 6 | Pt 100 Constant Current (+) | 16 | Power Supply DC (+) |
| 7 | Ground Connection | | |
| 8 | n.c. | | |

4.4. Connection of input signals

4.4.1. Input voltage $\pm 10\text{ V}$, $0 - 10\text{ V}$

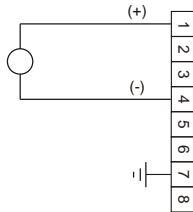

4.4.2. Input current $\pm 20\text{ mA}$, $4 - 20\text{ mA}$, $0 - 20\text{ mA}$

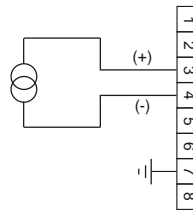

4.4.3. RTD 2-wire

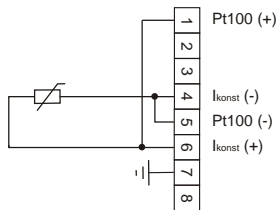

4.4.4. RTD 4-wire

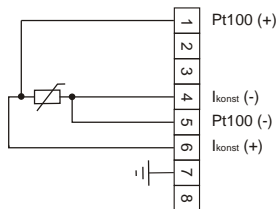

4.4.5. Thermocouple

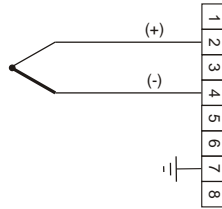

4.5. Connection of alarm output

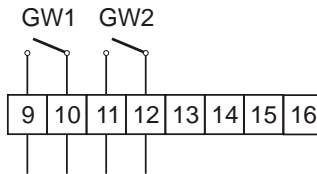

4.6. Connection of power supply voltage

4.6.1. Supply voltage 18 ... 36 V DC

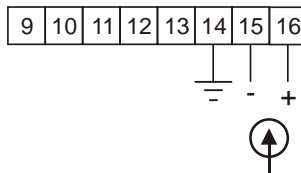

5. Startup procedur

Attention must be paid that the power supply voltage applied will agree with the voltage noticed at the name plate.

Switch the power supply on (supply voltage applied to 15 and 16). After about 2 seconds the display will indicate the applied input signal.



When delivered, the instrument is programmed with a standard configuration (default configuration). By programming the customer can change the standard configuration according to his measuring task.

Attention: When the instrument is built in a machine and the customer wants to change the configuration, attention must be paid, that no damage will occur to the machine!

6. Service instruction

There are three push buttons in the front. These push buttons can have different functions. The functions of the push buttons are determined by the used mode of the instrument. By this way the push buttons can be used for programming and for service.

6.1. Function of buttons and LEDs

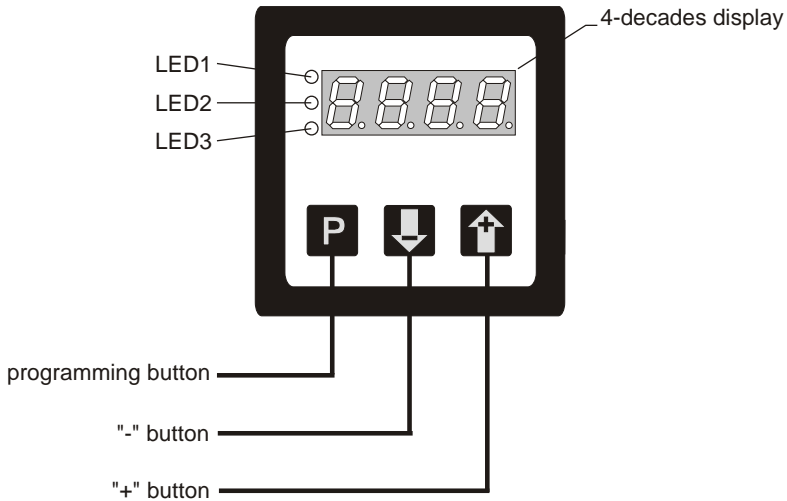

| LED 1 | LED 2 | LED 3 | Description |
|--------|--------|--------------|-----------------------------------|
| x | x | off | measured-, average- or hold value |
| x | x | red | MIN value is displayed |
| x | x | green | MAX value is displayed |
| x | x | green/blinks | Programming mode is active |
| x | off | x | alarm 2 is not active |
| x | lights | x | alarm 2 is active |
| x | blinks | off | alarm point 2 is displayed |
| x | blinks | green/blinks | alarm point 2 is changing |
| off | x | x | alarm 1 is not active |
| lights | x | x | alarm 1 is active |
| blinks | x | off | alarm point 1 is displayed |
| blinks | x | green/blinks | alarm point 1 is changing |

x = state of the LED is not considered

7. Modes



The operation and the programming of the panel meter is organized in several states:

- Operation level
- Access-code level
- Programm level

7.1. Operation level

In the state “operation level” the normal functions of the instrument are activated. A normal measurement cycle looks like below:

- Read measured value
- Linearization
- Displaying measured value
- Alarm (relay) output



Dependent on the programming of the parameter **0-10** (function of key ) , and **0-11** (function of key ) following key-functions are available in the operation level.

| Parameter 0-10 Function of pushbutton “-” |  | |
|--|---|------------------------|
| | By pressing | Pressing during 3 sec. |
| 0 | No Function | - |
| 1 | Reset the MIN/MAX Value | - |
| 2 | Taring | - |
| 3 | Clear Tara Value | - |
| 4 | Manual Reset of Alarms | - |
| 5 | Hold Function | - |
| 6 | Display Test | - |
| 7 | Display Measured Value | - |
| 8 | Display Average Value | - |
| 9 | Display MAX Value | - |
| 10 | Display MIN Value | - |
| 11 | Display Hold Value | - |
| 12 | Display Alarm Point 1 | Change Alarm Point 1 |
| 13 | Display Alarm Point 2 | Change Alarm Point 2 |

| Parameter 0-11 Function of pushbutton “+” |  | |
|--|---|------------------------|
| | By pressing | Pressing during 3 sec. |
| 0 | No function | - |
| 1 | Reset the MIN/MAX Value | - |
| 2 | Taring | - |
| 3 | Clear Tara Value | - |
| 4 | Manual Reset of Alarms | - |
| 5 | Hold Function | - |
| 6 | Display Test | - |
| 7 | Display Measured Value | - |
| 8 | Display Average Value | - |
| 9 | Display MAX Value | - |
| 10 | Display MIN Value | - |
| 11 | Display Hold Value | - |
| 12 | Display Alarm Point 1 | Change Alarm Point 1 |
| 13 | Display Alarm Point 2 | Change Alarm Point 2 |

7.2. Access-code level



The state “access-code level” becomes active by pressing the pushbutton  during the state “operation level”. The display shows “c000”. During the state “access-code level” the normal functions of the instrument are active.

| Push Button | Function |
|---|--------------------------------------|
|  | Confirm of the displayed access-code |
|  | Decrease the access-code |
|  | Increase the access-code |

7.3. Programm level

The state “programm level” becomes active by entering the right access-code. The access-code must be confirmed by pressing the pushbutton . The programming is organized in following steps:





- Selection of a programming level
- Selection of a parameter
- Edit of the selected parameter

| Pushbutton | Press | Pressing during 3 sec. |
|---|--|------------------------|
|  | Selection of - Programm level - Parameter | - |
|  | Decrease of - Programm level - Number of parameter - Value of parameter | - |
|  | Increase of - Programm level - Number of parameter - Value of parameter | - |

8. Procedure of programming

The procedure of programming is organized in several different steps.





Access to the selection of the programming levels

- Pressing pushbutton  => access-code enter is active
- The display shows "c000"
- Changing the access-code by pressing the pushbutton  or  and confirm the changed access-code by pressing the pushbutton 



If the entered access-code is not correct, the instrument will jump back to the state "operation level".

8.1. Changing or controlling of the parameters



Activating the programming routine

- Pressing pushbutton 
- LED 3 flashes green
- The display shows "c000"
- Changing the access-code by pressing the pushbutton  or 
- Confirm access-code by pressing the pushbutton 
- The display shows "P-00"



Leaving the programming routine

- Pressing the pushbutton  or  until the display shows "PEnd"
- Confirm the display "PEnd" by pressing the pushbutton 
- LED 3 is off
- The active state of the panel meter is "operation level"



Selection of the programming level

- Selecting the programming level by pressing the pushbutton  or 
- Confirm the programming level by pressing the pushbutton 
- The display shows the number of the parameter of the selected programming level
For example: "0-00" => parameter 0 of the programming level 0
For example: "1-00" => parameter 0 of the programming level 1



Leaving the programming level

- Pressing the pushbutton  or  until the display shows "xEnd"
For example: "0End" => leaving programming level 0
For example: "1End" => leaving programming level 1
- Confirm the display "xEnd" by pressing the pushbutton 
- The display shows the programming level
For example: "P-00" => for programming level 0
For example: "P-01" => for programming level 1

Selection of the parameter

- Selection the parameter by pressing the pushbutton  or 
- Confirm the parameter by pressing the pushbutton 
- The display shows the last programmed value of the selected parameter

Change and controll the selected parameter

- Change the value of the parameter by pressing the pushbutton  or 
- Confirm the value of the parameter by pressing the pushbutton 

The display shows the programming level and the number of the parameter

For example: "0-05" => parameter number 5 of programming level 0

For example: "1-08" => parameter number 8 of programming level 1

8.2. Overview of the programming levels

The parameters of the panel meter are organized in different programming levels.

P-00: Programming level to configuration the panel meter

The configuration is used to adapt the strain gauge bridge sensor to the panel meter.

P-01: Programming level of 10 point linearization

This programming level is used to program the values for the linearization.

P-02: Programming level of alarm output function

This programming level is used to program all settings of the alarm outputs.

8.3. Programming level for configuration P-00

| Param. | Description | Setting range | Default values |
|--------|---|---------------|----------------|
| 0-00 | Input range 0 -> Voltage 0...10 V 1 -> Voltage \pm 10 V 2 -> Current 0...20 mA 3 -> Current 4 to 20 mA 4 -> Current \pm 20 mA 5 -> RTD 2-Wire, -99.9...+600 °C 6 -> RTD 4-Wire, -99.9...+600 °C 7 -> Thermocouple type K -100 to +1300 °C 8 -> Thermocouple type J -100 to +1000 °C 9 -> Thermocouple type L -100 to +900 °C 10 -> Thermocouple type S 0 to 1750 °C 11 -> Thermocouple type T -100 to +400 °C 12 -> Thermocouple type U -80 to +400 °C 13 -> Thermocouple type R 0 to +1400 °C | 0 .. 13 | 0 |
| 0-01 | Calibration 0 -> Without calibrator 1 -> With calibrator | 0 .. 1 | 0 |
| 0-02 | Display value of the minimum input signal | -999 .. +9999 | 0 |
| 0-03 | Display value of the maximum input signal | -999 .. +9999 | +9999 |
| 0-04 | Programmable points 0 -> XXXX 1 -> XXX.X 2 -> XX.XX 3 -> X.XXX | 0 .. 3 | 0 |
| 0-05 | Filtering 1 -> No averaging X -> Number of averaging cycles | 1 .. 255 | 1 |
| 0-06 | Data source of the display 0 -> Direct measured value 1 -> Average value 2 -> MAX value 3 -> MIN value 4 -> Hold value | 0 .. 4 | 0 |

8. Procedure of programming

| Param. | Description | Setting range | Default values |
|--------|--|---------------|----------------|
| 0-07 | Data source of MAX-, MIN- and hold value 0 -> Direct measured value 1 -> Averaging value | 0 .. 1 | 0 |
| 0-08 | Configuration of digit 1 0 -> Display in steps of 1 1 -> Display in steps of 2 2 -> Display in steps of 5 3 -> Display in steps of 10 | 0 .. 3 | 0 |
| 0-09 | Reset time of the MAX/MIN value 0 -> No automatically reset X -> Reset time in seconds | 0 .. 100 | 0 |
| 0-10 | Function of push button "-" 0 -> No function 1 -> Reset MAX/MIN value 2 -> Taring 3 -> Clear tara value 4 -> Manual reset of alarms 5 -> Hold function 6 -> Display test 7 -> Display direct measured value 8 -> Display of average value 9 -> Display MAX value 10 -> Display MIN value 11 -> Display of hold value 12 -> Display/edit Alarm Point 1 13 -> Display/edit Alarm Point 2 | 0 .. 13 | 0 |
| 0-11 | Function of push button "+" 0 -> No function 1 -> Reset MAX/MIN value 2 -> Taring 3 -> Clear tara value 4 -> Manual reset of alarms 5 -> Hold function 6 -> Display test 7 -> Display direct measured value 8 -> Display of average value 9 -> Display MAX value 10 -> Display MIN value 11 -> Display of hold value 12 -> Display/edit Alarm Point 1 13 -> Display/edit Alarm Point 2 | 0 .. 13 | 0 |

8. Procedure of programming

| Param. | Description | Range | Default Value |
|--------|---|--------------|---------------|
| 0-12 | Cold junction 0 -> Thermocouple + manual cold junction 1 -> Thermocouple + internal cold junction 2 -> Only thermal junction 3 -> Temperature of the internal cold junction | 0 .. 3 | 2 |
| 0-13 | Manual cold junction in C° | 0 .. 50 | 0 |
| 0-14 | Lead resistant for RTD 2-wire | 0,0 .. 100,0 | 0,0 |
| 0-15 | Access-code | 0 .. 999 | 0 |
| 0End | Leaving programming level 0 | | |

Parameters which are not necessary in the programmed input range are locked. That means, the numbers of the parameters are displayed, but the value of the parameter can not be displayed and changed.

8.3.1. Scaling the display range

The overflow or underflow becomes active if the displayed value is greater or smaller than more as 1 % of the programmed display range (parameter 0-02 and 0-03).

- When **overflow** is activ the display shows “nnnn”
- When **underflow** is active the display shows “uuuu”



All ranges have been calibrated by the factory. There is no calibration necessary for normal usage. The ranges of RTD and thermocouples shouldn't be calibrated by the user.

There are two possibilities to assign the display range to the input signal

- Calibration without a calibrator
- Calibration with a calibrator

Calibration without a calibrator

The assignment of the display range to the minimal and maximal input signal is done by programming the parameter 0-02 and 0-03.

! The parameter 0-01 must be programmed to 0

Example:

Input range: $\pm 10\text{ V}$

Display range: ± 500

| Step | Param. | Range |
|------|--------|-------|
| 1. | 0-01 | 0 |
| 2. | 0-02 | -500 |
| 3. | 0-03 | +500 |
| 4. | 0End | End |

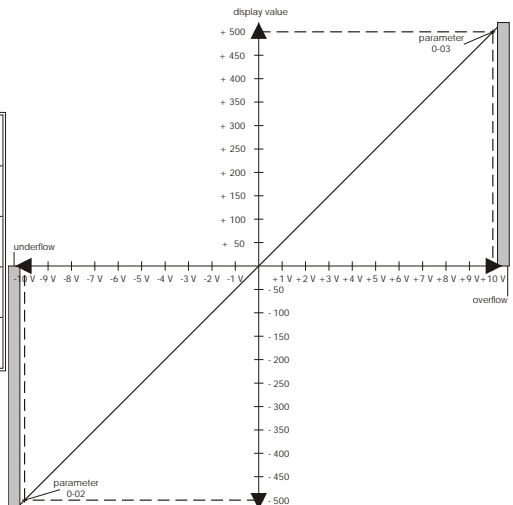

Calibration with calibrator

The assignment of the display range to the minimal and maximal input signal is done by programming the parameter 0-02 and 0-03. The minimal and maximal input signal must be connected direct to the panel meter when programming the parameter 0-02 or 0-03.

The parameter 0-01 must be programmed to 1.



Attention: By the calibration with a calibrator the factory settings of the adjustment values are changed. Make use of this possibility only with a suitable calibrator. The factor settings of the adjustment values are changed as soon as displaying the value of the parameter 0-02 or 0-03.

Example:

Input signal range: +0,5 V to +8,6 V

Display range: +100 to +1000

| step | param. | procedure | range |
|------|--------|--------------------------------------|-------|
| 1. | 0-01 | - | 1 |
| 2. | - | connecting 0,5 V to the signal input | - |
| 3. | 0-02 | - | 100 |
| 4. | - | connecting 8,6 V to the signal input | - |
| 5. | 0-03 | - | 1000 |
| 6. | 0End | - | end |

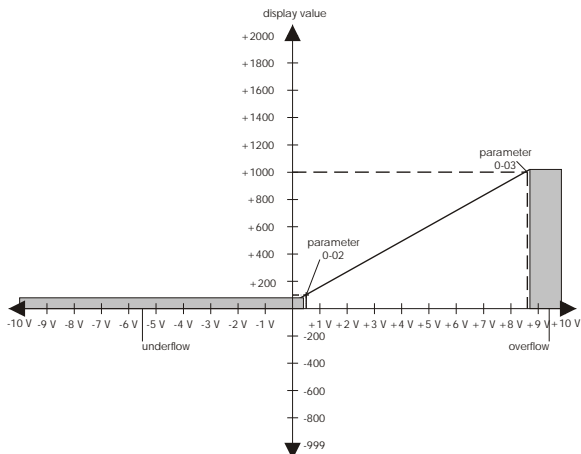

8.4. Programming level of linearization P-01

| Param. | Description | Setting range | Default values |
|--------|---------------------------------------|-------------------------------|----------------|
| 1-00 | Number of linearization points | 2 .. 10 | 2 |
| 1-01 | Linearization point 1 Input value | ± max. prog. display range | 0 |
| 1-02 | Linearization point 1 Output value | ± max. prog. display range | 0 |
| 1-03 | Linearization point 2 Input value | ± max. prog. display range | +9999 |
| 1-04 | Linearization point 2 Output value | ± max. prog. display range | +9999 |
| 1-05 | Linearization point 3 Input value | ± max. prog. display range | 0 |
| 1-06 | Linearization point 3 Output value | ± max. prog. display range | 0 |
| 1-07 | Linearization point 4 Input value | ± max. prog. display range | 0 |
| 1-08 | Linearization point 4 Output value | ± max. prog. display range | 0 |
| 1-09 | Linearization point 5 Input value | ± max. prog. display range | 0 |
| 1-10 | Linearization point 5 Output value | ± max. prog. display range | 0 |
| 1-11 | Linearization point 6 Input value | ± max. prog. display range | 0 |
| 1-12 | Linearization point 6 Output value | ± max. prog. display range | 0 |
| 1-13 | Linearization point 7 Input value | ± max. prog. display range | 0 |
| 1-14 | Linearization point 7 Output value | ± max. prog. display range | 0 |
| 1-15 | Linearization point 8 Input value | ± max. prog. display range | 0 |
| 1-16 | Linearization point 8 Output value | ± max. prog. display range | 0 |

| | | | |
|--------|--|-----------------------------------|-------------------|
| 1-17 | Linearization point 9 Input value | \pm max. prog. display range | 0 |
| 1-18 | Linearization point 9 Output value | \pm max. prog. display range | 0 |
| Param. | Description | Setting range | Default values |
| 1-19 | Linearization point 10 Input value | \pm max. prog. display range | 0 |
| 1-20 | Linearization point 10 Output value | \pm max. prog. display range | 0 |
| 1End | Leave programming level P-01 | | |

8.4.1. 10-point-linearization

The panel meter include the possibility of a linearization up to 10 points.

Linearization of the input signal

- only for the input range 0 to 4 (current or voltage) possible
- not for RTD or thermal junction
- only in the programmed display range possible (parameter 0-02 and 0-03)

Performing a linearization

- Insert the number of linearization points (parameter 1-00)
- For each point must be programmed two values, the input value and the corresponding output value
- By leaving the programming routine, the linearization points will sort in rising sequence

Reset the linearization points by

- Changing the parameter 0-02 or 0-03
- Changing the input range (parameter 0-00)

Reset the linearization points to

- Number of linearization points = 2 (parameter 1-00)
- Linearization point 1 = parameter 0-02
- Linearization point 2 = parameter 0-03

8.5. Programming level of alarms P-02

| Param. | Description | Setting range | Default values |
|--------|--|--------------------------------|----------------|
| 2-00 | Alarm output 1, data source 0 -> Alarm 1 off 1 -> Alarm 1 to direct measured value 2 -> Alarm 1 to average value 3 -> Alarm 1 to maximum value 4 -> Alarm 1 to minimum value 5 -> Alarm 1 to hold value | 0 .. 5 | 0 |
| 2-01 | Alarm output 1, high or low 0 -> Contact closed by low limit 1 -> Contact closed by high limit 2 -> Contact open by low limit 3 -> Contact open by high limit | 0 .. 3 | 0 |
| 2-02 | Alarm output 1, alarm point | \pm max. prog. display range | Param. 0-03 |
| 2-03 | Alarm output 1, hysteresis | 1 .. 1000 | 1 |
| 2-04 | Alarm output 1, release delay time in seconds | 0 .. 60 | 0 |
| 2-05 | Alarm output 1, operate delay time in seconds | 0 .. 60 | 0 |
| 2-06 | Alarm output 2, data source 0 -> Alarm 2, off 1 -> Alarm 2 to direct measured value 2 -> Alarm 2 to average value 3 -> Alarm 2 to maximum value 4 -> Alarm 2 to minimum value 5 -> Alarm 2 to hold value | 0 .. 5 | 0 |
| 2-07 | Alarm output 2, high or low 0 -> Contact closed by low limit 1 -> Contact closed by high limit 2 -> Contact open by low limit 3 -> Contact open by high limit | 0 .. 3 | 0 |
| 2-08 | Alarm output 2, alarm point | \pm max. prog. display range | Param. 0-03 |
| 2-09 | Alarm output 2, hysteresis | 1 .. 1000 | 1 |
| 2-10 | Alarm output 2, release delay time in seconds | 0 .. 60 | 0 |
| 2-11 | Alarm output 2, operate delay time in seconds | 0 .. 60 | 0 |
| 2End | Leave programming level P-02 | | |

8.5.1. Alarm functions

Data sources of the alarms:

- Direct measured value
- Average value
- Maximum value
- Minimum value
- Hold value

Indication of alarms

- Two relay output
- LED 1 and LED 2 at the front

Reset the alarms by:

- Changing the parameter 0-02 or 0-03
- Changing the input range (parameter 0-00)



Reset the alarms to:

- Alarm value = parameter 0-03
- The alarms are switched off

Programmable functions of the alarms

- Alarm value
- Hysteresis
- Release delay time and operate delay time
- High or low alarm

Manual alarm reset

In dependence of programming of the functional push button  or  (parameter 0-10 and 0-11) is the alarm output latched or not latched.

Alarm output latched:



- If the the functional pushbutton is programmed to manual alarm reset.
- Reset the latched alarm output by pressing the functional pushbutton.

Alarm output not latched:

- If the functional pushbuttons are not programmed to manual alarm reset

Display and edit the alarm values

The alarm points can displayed and edited on different kinds.

- Inside the programmig routine, which is reached over the access code. During the programming routine no measurement is taken.
- Outside the programming routine by pressing the pushbutton  or  during normal measurement are taken.

The edition is end when pressing the pushbutton  . Therefore the alarm value will be up to date (see 7.1 Operation level).

8.5.2. Alarm high setpoint

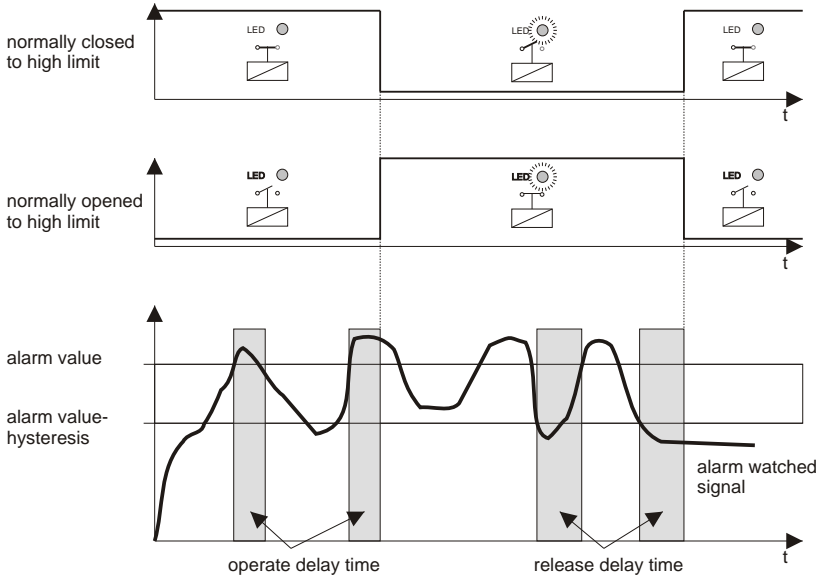

8.5.3. Alarm low setpoint

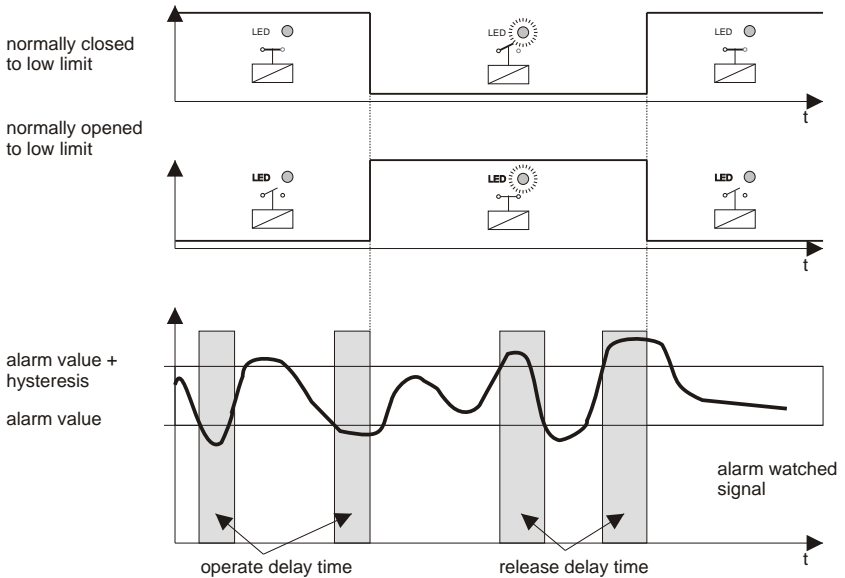

8.6. Programming quick reference

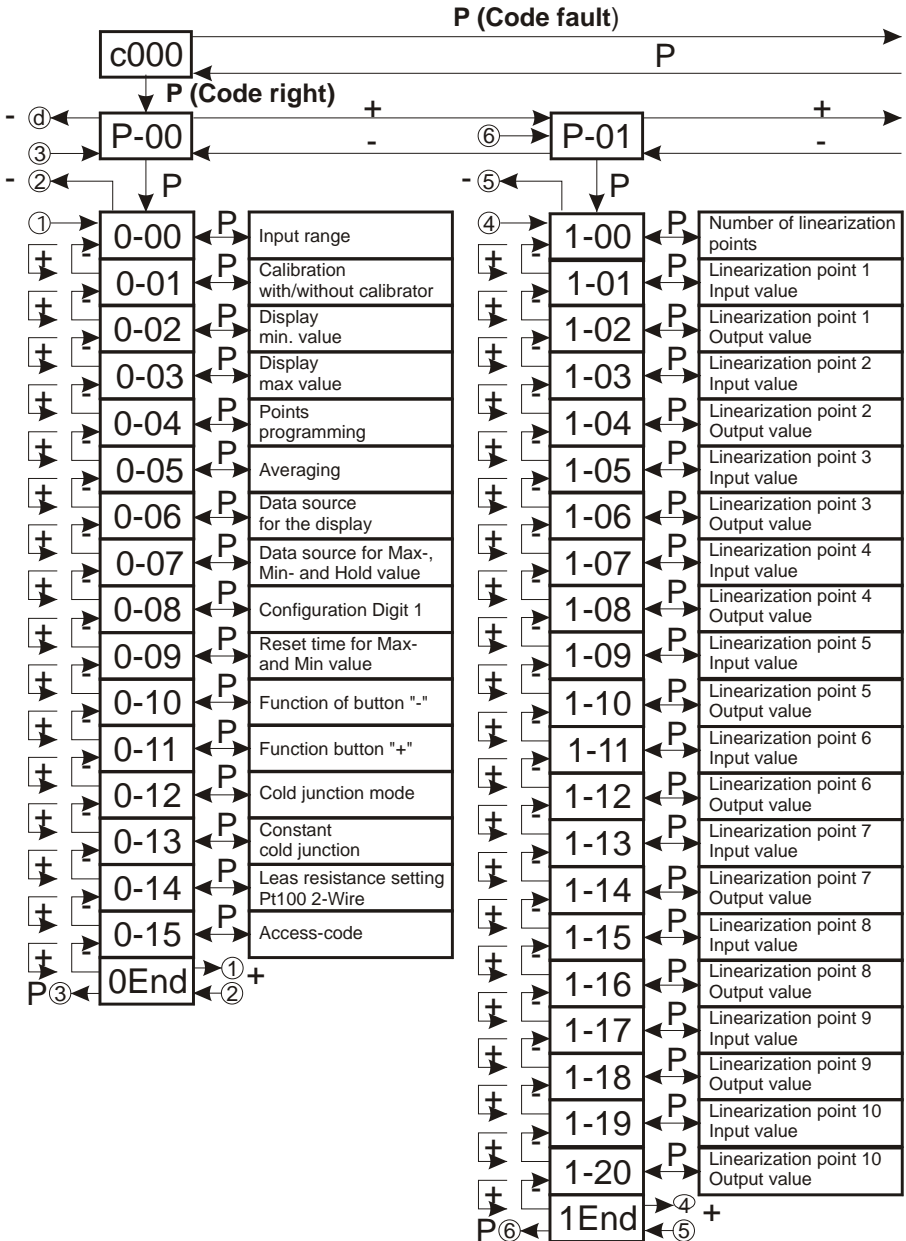

8. Procedure of programming

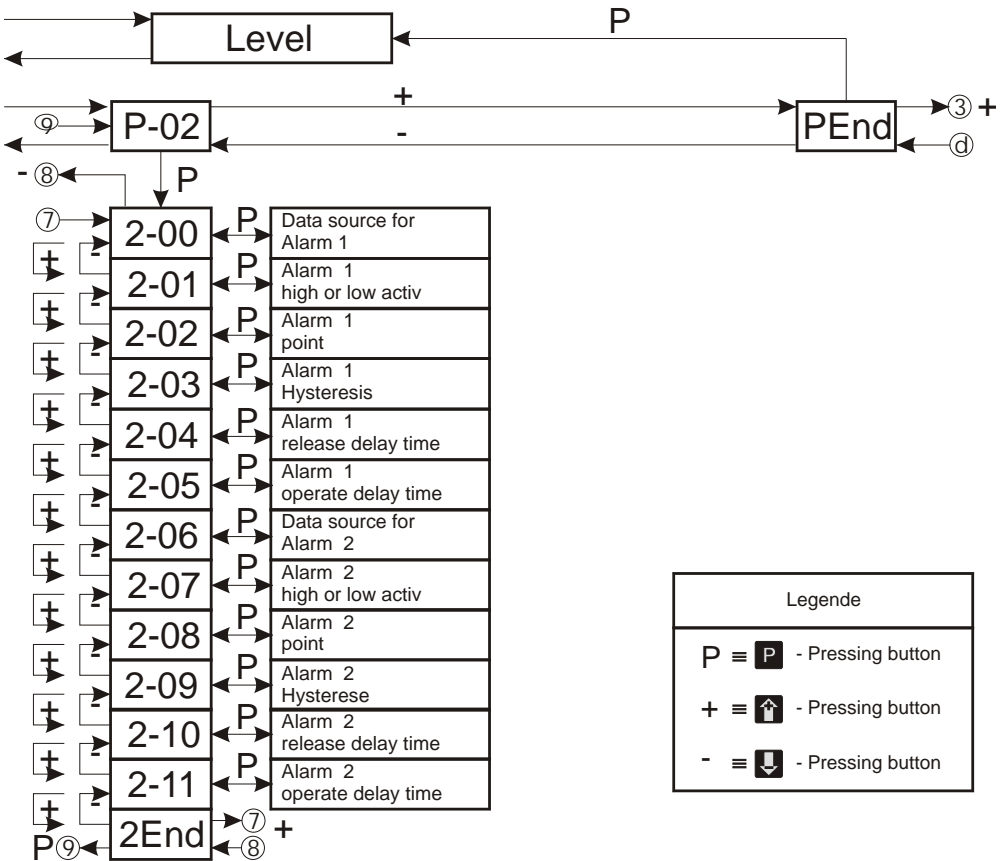



9. Software functions



9.1. MIN/MAX value detection

The panel meter include a MIN/MAX value detection. The maximum and minimum value can be displayed with the frontal push buttons or with the digital user inputs. Besides the maximum and minimum value can be controlled of the alarm output.

Reset the maximum and minimum values:

- Automatically by the programmed memory reset time (parameter 0-09)
- By pressing the pushbutton  or  (parameter 0-10 and 0-11)
- By leaving the programming routine

Display the maximum and minimum value

- By programming as data source of the display (parameter 0-06)
- By pressing the pushbutton  or  (parameter 0-10 and 0-11)

Indication of the displayed maximum and minimum value

- LED 3 lights green => maximum value is displayed
- LED 3 lights red => minimum value is displayed

9.2. Averaging

The panel meter include a programmable single pole digital filter. The filter is used to smooth analog input data in noisy environments.

Digital filtering is performed by forming the average of input signals. By a special algorithm it is provided that a smooth filtering will be achieved.

$$\text{time constant} = \frac{\text{number of measurements}}{\text{measuring rate}}$$

If the input signal is a step function, 99,3 % of the final measurement value will be reached within 5 time constants.

9.3. Taring

By activating the tara function, the input value will be taken over into the tara memory. The tara value is being subtracted and effects the input value and the mean value. The tara value will be placed in a nonvolatile memory and is also present after power off the instrument.

Activating the tara function by:

- By pressing the pushbutton  or  (parameter 0-10 and 0-11)

Clear the tara value by:

- By pressing the pushbutton  or  (parameter 0-10 and 0-11)

Reset the tara value by:

- Changing the parameter 0-02 or 0-03
- Changing the input range (parameter 0-00)

9.4. Display hold

When activating the hold function the value of the data source, which is programmed in parameter 0-07 is taken over into the hold memory. If the hold function is not active the hold value is the same as the value of the data source, which is programmed in parameter 0-07.



Activating the hold function by:

- By pressing the pusbutton  or  (parameter 0-10 and 0-11)

Reset the hold value

- By leaving the programming routine

Display the hold value by

- Programming as data source of the display (parameter 0-06)
- Pressing the pushbutton  or  (parameter 0-10 and 0-11)

The hold value can:

- Show on display
- Watched by alarm output

9.5. Display test

When activating the display test all segments of the display are light on. The display shows “8.8.8.8.”

Activating the display test :



10. Cold junction

- By pressing the pushbutton  or  (parameter 0-10 and 0-11)

9.6. Main reset

The main reset is performed by pressing a key combination at the front of the panel meter. By doing this all parameters are setting to the default value. The value of the parameter 0-00 (input range) is not changing by the main reset. During the main reset the display shows "Inl."

Perform the main reset by

Pressing the pushbuttons  and  and  at the same time during 5 sec. .

10. Cold junction

The panel meter include an internal and a manual temperatur compensation with cold junction reference temperatur.

The internal cold junction is performed by a integrated temperatur sensor. The manu- al cold junction is performed by a value set by programming the parameter 0-13.

Programmable selection by parameter 0-12:

- Thermocouple + manual cold junction
- Thermocouple + internal cold junction
- Only Thermocouple
- Temperatur of the integrated temperatur sensor

11. RTD Lead Resistance Adjustment

RTD 2-Wire

- A lead resistance adjustment is necessary and can be taken by programming the parameter 0-14 (lead resistance in)
The maximum value of the lead resistance is 100 .

RTD 4-Wire

- No lead resistance adjustment is necessary

12. Error codes

12.1. Sensor break detection

- The display flashes and indicate "Er01"
- Indication of sensor break by RTD or thermocouple

13. Technical Specifications

13.1. Electrical datas

Input ranges

| | |
|--|--|
| voltage | : ± 10 V, $\pm 0,01$ %, ± 1 Digit |
| impedance | : 1 M |
| current | : ± 20 mA, $\pm 0,01$ %, ± 1 Digit |
| impedance | : 10 |
| thermal junction | |
| Ni-CrNi (K) | : -100 to +1300 °C |
| accuracy | : ± 1 °C, ± 1 Digit |
| Fe-CuNi (J) | : -100 to +1000 °C |
| accuracy | : ± 1 °C, ± 1 Digit |
| Fe-CuNi (L) | : -100 to +900 °C |
| accuracy | : ± 1 °C, ± 1 Digit |
| PtRh90/10%-Pt (S) | : 0 to +1750 °C |
| accuracy from 0 to 250 °C | : ± 5 °C, ± 1 Digit |
| accuracy from 250 to 1750 °C | : ± 1 °C, ± 1 Digit |
| Cu-CuNi (T) | : -100 to +400 °C |
| accuracy | : ± 1 °C, ± 1 Digit |
| Cu-CuNi (U) | : -80 to +1400 °C |
| accuracy | : ± 1 °C, ± 1 Digit |
| PtRh87/13%-Pt (R) | : 0 bis +1400 °C |
| accuracy | : ± 2 °C, ± 1 Digit |
| cold junction compensation | |
| internal | : 0 - 50 °C |
| accuracy | : ± 1 °C |
| constant | : 0 - 50 °C |
| RTD | : 2-wire/4-wire |
| resolution | : -99,9 to +600,0 °C |
| accuracy | : 0,1 °C |
| Resolution of the A/D-Converter | : $\pm 0,5$ °C, ± 1 Digit |
| Conversion rate | : 16 Bit |
| voltage, current | : 10/s |
| temperature | : 5/s |
| Alarm outputs | : 2 relays (programmable as opened contact or closed contact) |
| Signaling | : 2 LEDs at the front |

13. Technical Specifications

| | |
|----------------|-----------------------|
| Switch voltage | : 250 V AC / 250 V DC |
| Switch current | : 5 A AC / 5 A DC |
| Switch power | : 750 VA / 100 W |

| | |
|------------------------|-----------------|
| Power supply DC | : 18 .. 36 V DC |
| Power consumption | : approx. 80 mA |
| Isolation voltage | : 500 V / 1 min |

13.2. Mechanical datas

| | |
|-----------------------------------|---|
| Display | : 4 decades, 8 mm, red : decimal point programmable : preliminary zero suppression : - sign at negative values |
| Operation, keyboard design | : front membrane with push buttons |
| Case | : switch board mounting DIN 43 700 |
| Dimensions (B x H x T) | : 48 x 48 x 85 mm |
| Depth | : 100 mm incl. screw terminal |
| Mounting | : switch board mounting |
| Weight | : approx. 250 g |
| Connection | : plug-in screw terminal |
| Signal inputs | : max. \square 1,5 mm ² |
| Alarm outputs | : max. \square 1,5 mm ² |
| Power inputs | : max. \square 1,5 mm ² |

13.3. Environmental conditions

| | |
|-----------------------|--|
| Operating temperature | : 0 .. 50 °C |
| Storage temperature | : -20 .. 70 °C |
| Humidity | : < 80 %, not-condensing |
| Protection | : protection class II |
| Front protection | : IP 54 |
| Field of application | : connectors IP 20 : class 2 : overvoltage protection II |
| CE | : in conform with 89/336/EWG : NSR 73/23/EWG |

14. Ordering Information

| | | | | | | |
|------------------|----------|--|----------|--|--|------------------------------------|
| DM 2400 - | 0 | | 0 | | | |
| | | | | | | |
| | | | | | | Housing |
| | | | | | | 0 switch board mounting |
| | | | | | | Front frame color |
| | | | | | | 0 black |
| | | | | | | Front design |
| | | | | | | 1 no logo |
| | | | | | | Reserved |
| | | | | | | Power supply |
| | | | | | | 0 5 V DC, ± 10 %, isolated |
| | | | | | | 1 12 V DC, ± 10 %, isolated |
| | | | | | | 2 18 .. 36 V DC, isolated |
| | | | | | | Reserved |

15. Notes

ERMA - Electronic GmbH
Max-Eyth-Str. 8
D-78194 Immendingen

Telefon (+49 7462) 2000-0
Fax (+49 7462) 2000-29
email info@erma-electronic.com
Web www.erma-electronic.com

