CM 9001

Digital Signal Converter

for incremental encoder signals

Instruction Manual



ERMA

Electronic GmbH

Warranty

For delivered products our "Allgemeine Lieferungs- und Zahlungsbedingungen" are effective. In no event we or our suppliers shall be liable for any other damages whatsoever (including, without limitation, damages for loss of business profits, business interruption or other pecuniary loss) arising out of or inability to use this product.

All our products are warranted against defective material and workmanship for a period of two (2) years from date of delivery. If it is necessary to return the product, the sender is responsible for shipping charges, freight, insurance and proper packaging to prevent breakage in transit. The warranty does not apply to defects resulting from action of the buyer, such as mishandling, improper interfacing, operation outside of design limits, improper repair or unauthorized modification.

Trademarks

All trademarks that are named or portrayed in the text are registered trademarks of its owner. The trademarks are recognized by ERMA-Electronic.

CONTENTS

1. Description	5
2. Safety instructions	6
2.1. Symbol explanation	6
3. Mounting	7
3.1. Place of operation	7
3.2. Mounting of digital panel meter	7
3.2.1. Housing for switch board	7
4. Electrical connection	8
4.1. General instructions	8
4.2. Hints against noisy environment.	8
4.3. Connection and pin assignment	9
4.4. Connection of signal inputs	10
4.4.1. Incremental counter A 90° B	10
4.4.2. UP/DOWN counter A with direction B.	10
4.4.3. Pulse counter A and B.	10
4.4.4. Frequency-/Rotation speed measurement	11
4.4.5. Cycle duration/Pulse duration measurement	11
4.4.6. Time meter with start/stop-signal	11
4.5. Connection of digital user input	12
4.6. Connection of alarm outputs (relay)	12
4.7. Connection of accessory power supply output	12
4.8. Connection of analog output.	12
4.9. Connection of RS 485 interface	13
4.10. Connection of power supply voltage.	13
4.10.1. Supply voltage 18 ...36 V DC	13
5. Startup procedure	13
6. Pushbuttons- and LED-functions	14
6.1. Function of buttons and LEDs.	14
7. Modes	15

7.1.	Operation level	15
7.2.	Access-code level	16
7.3.	Programming level.	17
8.	Procedure of programming	18
8.1.	Changing or controlling parameters	18
8.2.	Overview of the programming level	19
8.3.	Programming level for configuration P-00	20
8.4.	Programming level of alarm output P-02	23
8.4.1.	Alarm output functions.	24
8.4.2.	Alarm high setpoint	26
8.4.3.	Alarm low setpoint	26
8.5.	Programming level of analog output P-03	27
8.5.1.	Scaling of the analog output.	28
8.5.2.	Analog output at overflow and underflow	28
8.6.	Programming level of serial interface P-04	29
8.6.1.	Transmission Mode	29
8.7.	Programming quick reference	30
9.	Description of modes	32
9.1.	Counter modes	32
9.2.	Frequency-/Rotation speed meter modes	33
9.2.1.	Considerations for use rotation speed meter	33
9.3.	Time meter modes.	34
9.4.	Scaling factor and offset value.	34
9.4.1.	Tabulation	35
9.5.	Time-Out.	35
10.	Input ports	35
10.1.	Input filter	35
11.	Software functions	36
11.1.	Data buffering	36
11.2.	MIN/MAX value detection	36
11.3.	Hold function.	37

11.4. Display test	37
11.5. Main reset	37
12. Technical Specifications	38
12.1. Electrical datas.	38
12.2. Mechanical datas	39
12.3. Environmental conditions	40
13. Ordering information	40

Stand : 10.2011
cm9001_man_en.vp
Technical subjects to change

1. Description

The digital panel meter model CM 9001 is an universal instrument for displaying and controlling of the most values witch are derivable from impuls signals. The digital panel meter is provided with four signal inputs and two other programmable digital user inputs.

Folowing modes are realisable with the digital panel meter CM 9001:

- Incremental counter A 90° B x 1 , A 90° B x 2, A 90° B x 4
- UP/DOWN counter A + direction B
- Pulse counter A, A + B, A - B, A/B, (A-B)/A, (B-A)/A
- Frequency-/rotation speed measurement A, A + B, A - B, A/B, (A-B)/A, (B-A)/A
- Cycle duration or pulse duration measurement
- Time meter with start-/stop-signal

Standard hardware

- Two relay alarm outputs
- Analog output 0 - 10 V, 2 - 10 V, 0 - 20 mA, 4 - 20 mA
- Two programmable digital user inputs
- Three programmable pushbutton

Standard software

- Input level and input logic
- Scaling factor
- Offset value
- MAX/MIN value detection
- Auto-Reset of MAX/MIN value
- Display test and display hold (latch)

Following options are available

- RS485 interface

2. Safety instructions

This instrument is produced in accordance with Class II of IEC 348 and VDE 0411. When delivered the instrument has been tested to meet all functions described. Before installing the instrument please read the mounting and servicing instructions.

We have no liability or responsibility to customer or any other person or entity with respect to any liability, loss or damage caused or alleged to be caused directly or indirectly by equipment or software sold or furnished by us. Read the installation instruction carefully. No liability will be assumed for any damage caused by improper installation.

Inspect the instrument module carton for obvious damage. Be shure there are no shipping and handing damages on the module before processing. Do not apply power to the instrument if it has been damaged.

ERMA's warranty does not apply to defects resulting from action of the buyer, such as mishandling, improper interfacing, operation outside of design limits, improper repair or unauthorized modifications.

2.1. Symbol explanation



Caution



Attention



Instruction



Tip

Caution: Will be used at **dangerous for life and health !**

Attention: Will cause **damage**

Instruction: If not noticed, **trouble** may occur

Tip: Useful hints for **better operation**

3. Mounting

3.1. Place of operation

Attention must be paid to the protection against humidity, dust and high temperatures at the place of operation.

3.2. Mounting of digital panel meter

3.2.1. Housing for switch board

- Insert the case into the panel cutout (according to DIN 43700: $92^{+0,8} \times 45^{+0,6}$ mm)
- Tighten the screws alternately, using enough pressure to get good retention and sealing at the panel.

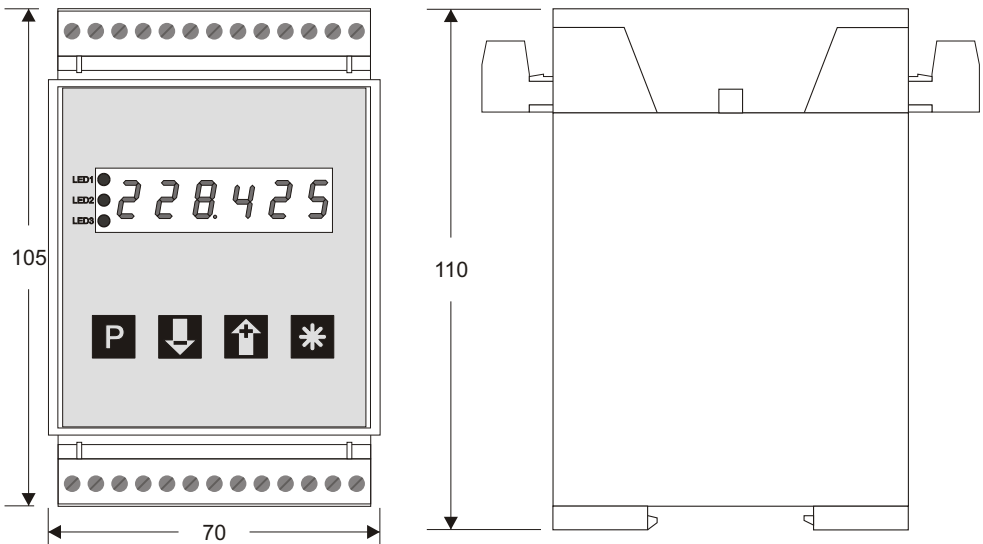

4. **Electrical connection**

4.1. **General instructions**



- It is forbidden to plug or unplug connectors with voltage applied
- Attach input and output wires to the connectors only without voltages applied
- Cords must be provided with sleeves
- Attention must be paid that the power supply voltage applied will agree with voltage noticed at the name plate.
- The instrument has no power-on switch, so it will be in operation as soon as the power is connected.

4.2. **Hints against noisy environment**

All inputs and outputs are protected against noisy environment and high voltage spikes. Nevertheless the location should be selected to ensure that no capacitive or inductive interference can have an effect on the instrument or the connection lines.

It is advisable:



- To use shielded cables.
- The wiring of shields and ground (0V) should be star-shaped.
- The distance to interference sources should be as long as possible. If necessary, protective screen or metal enclosures must be provided.
- Coils of relays must be supplied with filters.
- Parallel wiring of input signals and AC power lines should be avoided.

4.3. Connection and pin assignment

All inputs and outputs are connectors, designed as plug-in screw terminals.



Pin assignmentment

1	Power supply N, DC (+)	14	Signal input A
2	Power supply L, DC (-)	15	Signal input B
3	Ground connection	16	Reset input
4	Analog output 0/2 - 10 V	17	Gate input
5	Analog output 0/4 - 20 mA	18	GND (0 V)
6	Analog output, GND (-)	19	Ground connection
7	Option RS 485, A (+)	24	Digital user input 1
8	Option RS 485, B (-)	25	Digital user input 2
9	Option RS 485, GND	26	GND of digital inputs
10/11	Alarm (relay) output 1		
12/13	Alarm (relay) output 2		

4.4. Connection of signal inputs

4.4.1. Incremental counter A 90° B

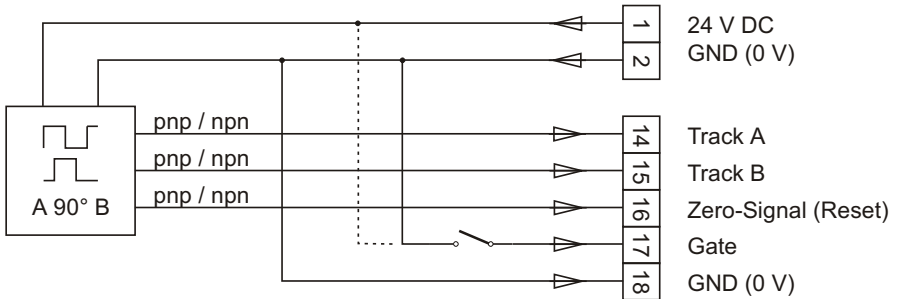

4.4.2. UP/DOWN counter A with direction B

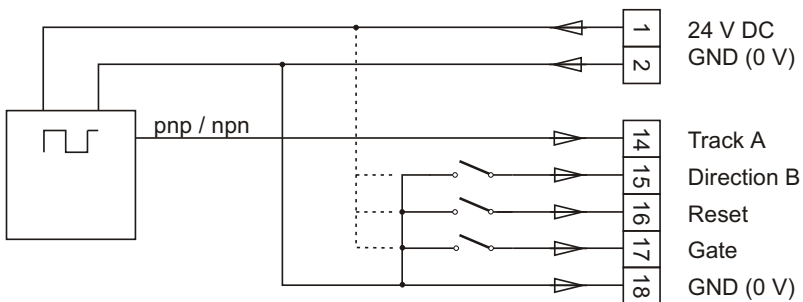

4.4.3. Pulse counter A and B

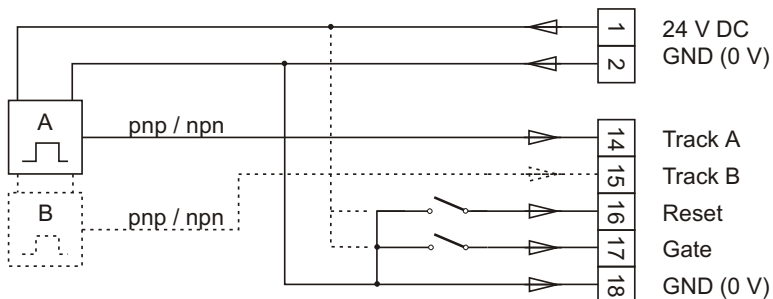

4.4.4. Frequency-/Rotation speed measurement

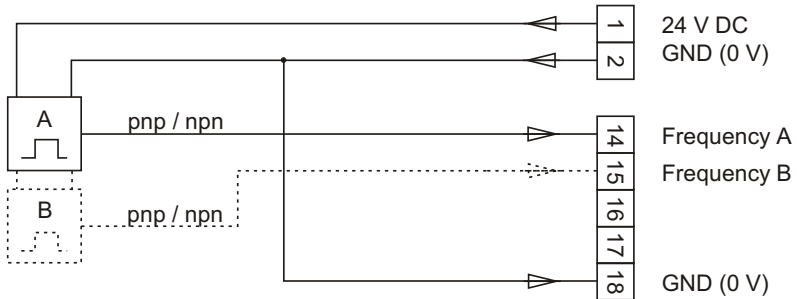

4.4.5. Cycle duration/Pulse duration measurement

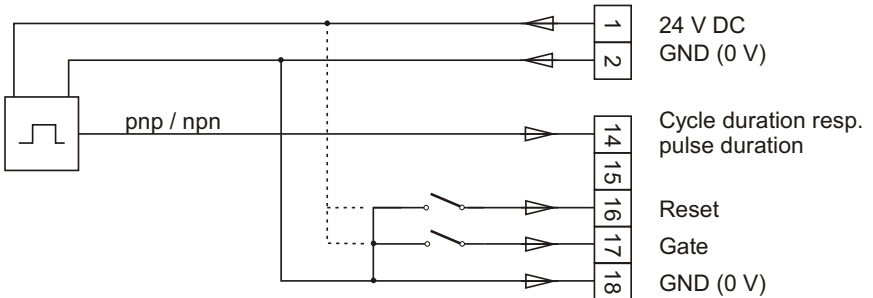

4.4.6. Time meter with start/stop-signal

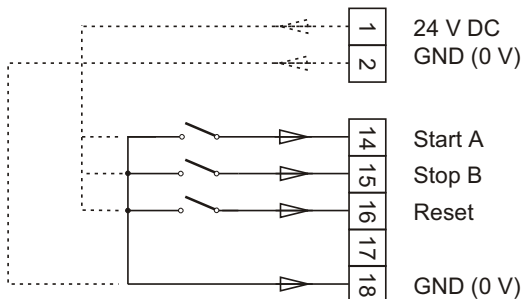

4.5. Connection of digital user input

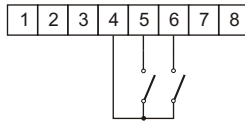

Digital input 1

- active => Connecting Screw Terminal 24 to 26
- Connecting to Ground, low active

Digital input 2

- active => Connecting Screw Terminal 25 to 26
- Connecting to Ground, low-active

4.6. Connection of alarm outputs (relay)

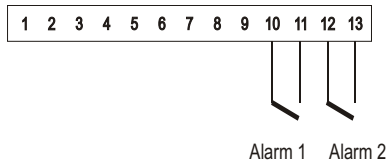

4.7. Connection of accessory power supply output

24 V DC (only at AC-Version)

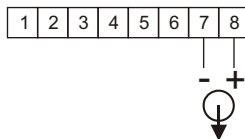

4.8. Connection of analog output

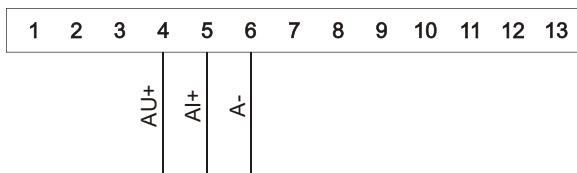

4.9. Connection of RS 485 interface

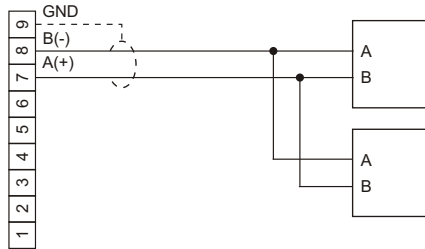

4.10. Connection of power supply voltage



4.10.1. Supply voltage 18 ...36 V DC

5. Startup procedure



Attention must be paid that the power supply voltage applied will agree with the voltage noticed at the name plate. Switch the power supply on (supply voltage applied to 14 and 15). After about 2 seconds the display will indicate the applied input signal.



When delivered, the instrument is programmed with a standard configuration (default values). By programming the customer can change the standard configuration according to his measuring task.

Attention ! When the instrument is built in a machine and the customer wants to change the configuration, attention must be paid, that no damage will occur to the machine!

6. Pushbuttons- and LED-functions

There are four push buttons in the front. These push buttons can have different functions. The functions of the push buttons can be used for programming and for service.

6.1. Function of buttons and LEDs

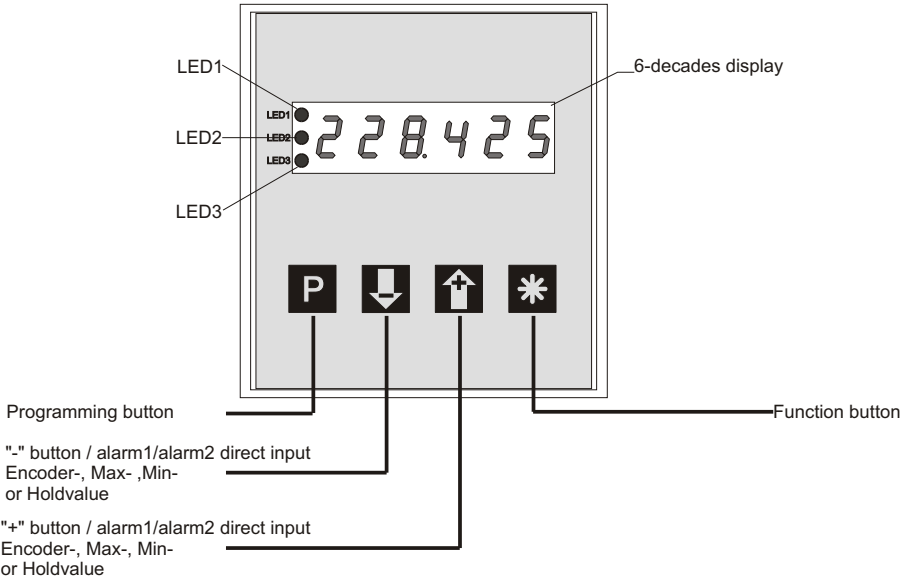

LED 1	LED 2	LED 3	Description
x	x	off	measured- or hold value is displayed
x	x	red	MIN value is displayed
x	x	green	MAX value is displayed
x	x	green/flashes	programming mode is activated
x	off	x	alarm 2 is not activated
x	lights	x	alarm 2 is activated
x	flashes	off	alarm point 2 is displayed
x	flashes	green/flashes	alarm point 2 is changed
off	x	x	alarm 1 is not activated
lights	x	x	alarm 1 is activated
flashes	x	off	alarm point 1 is displayed
flashes	x	green/flashes	alarm point 1 is changed

x = state of the LED is not considered

7. Modes



The operation and the programming of the panel meter is organized in several states:

- Operation level
- Access-code level
- Programm level

7.1. Operation level

In the state “operation level” the normal functions of the instrument are activated. A normal measurement cycle looks like below:

- Read the input signals, calculate and display
- Evaluate the digital inputs
- Alarm outputs
- Analog output

Dependent on the programming of the parameter **0-13** (function of key ) , **0-14** (function of key ) and **0-12** (function of key ) , following key-functions are available in the operation level.

Parameter 0-12 Function of pushbutton “*”	 By pressing
0	No function
1	Reset the MIN/MAX value
2	Manual reset of alarms
3	Counter reset
4	start single serial transmission (only by option interface)





7. Modes

Parameter 0-13 Function of pushbutton “-”		
	By pressing	Pressing during 3 sec.
0	No function	-
1	Display input signal	-
2	Display MAX value	-
3	Display MIN value	-
4	Display hold value	-
5	Display alarm point 1	Change alarm point 1
6	Display alarm point 2	Change alarm point 2

Parameter 0-14 Function of pushbutton “+”		
	By pressing	Pressing during 3 sec.
0	No function	-
1	Display input signal	-
2	Display MAX value	-
3	Display MIN value	-
4	Display hold value	-
5	Display alarm point 1	Change alarm point 1
6	Display alarm point 2	Change alarm point 2

7.2. Access-code level





The state “access-code level” becomes active by pressing the pushbutton  during the state “operation level”. The display shows “c000”. During the state “access-code level” the normal functions of the instrument are active.

pushbutton	Function
	Confirm of the displayed access-code
	Increase the access-code
	Decrease the access-code
	Programmed function

7.3. Programming level

The state “programm level” becomes active by entering the right access-code. The access-code must be confirm by pressing the pushbutton . The programming is organized in following steps:



- Selection of a programming level
- Selection of a parameter
- Change of the selected parameter

Pushbutton	Press	Pressing during 3 sec.
	Selection of - Programming level - Parameter	-
	Decrease of - Programming level - Number of parameter - Value of parameter	-
	Increase of - Programming level - Number of parameter - Value of parameter	-
	-	Break the programming routine

8. Procedure of programming

The procedure of programming is organized in several different steps.



Access to the selection of the programming levels

- Pressing pushbutton **P** => access-code enter is active
- The display shows "c000"
- Changing the access-code by pressing the pushbutton  or  and confirm the changed access-code by pressing the pushbutton **P**



If the entered access-code is not correct, the instrument will jump back to the state "operation level".

8.1. Changing or controlling parameters



Activating the programming routine

- Pressing pushbutton **P**
- LED 3 flashes green
- The display shows "c000"
- Changing the access-code by pressing the pushbutton  or 
- Confirm access-code by pressing the pushbutton **P**
- The display shows "P-00"



Leaving the programming routine

- Pressing the pushbutton  or  until the display shows "PEnd"
- Confirm the display "PEnd" by pressing the pushbutton **P**
- LED 3 is off
- The active state of the panel meter is "operation level"



Selection of the programming level

- Selecting the programming level by pressing the pushbutton  or 
- Confirm the programming level by pressing the pushbutton **P**
- The display shows the number of the parameter of the selected programming level
For example: "0-00" => parameter 0 of the programming level 0
For example: "2-00" => parameter 0 of the programming level 2



Leaving the programming level

- Pressing the pushbutton  or  until the display shows "xEnd"
For example: "0End" => leaving programming level 0
For example: "2End" => leaving programming level 2
- Confirm the display "xEnd" by pressing the pushbutton 
- The display shows the programming level
For example: "P-00" => for programming level 0
For example: "P-02" => for programming level 2

Selection of the parameter

- Selection the parameter by pressing the pushbutton  or 
- Confirm the parameter by pressing the pushbutton 
- The display shows the last programmed value of the selected parameter

Change and control the selected parameter

- Change the value of the parameter by pressing the pushbutton  or 
- Confirm the value of the parameter by pressing the pushbutton 
- The display shows the programming level and the number of the parameter
For example: "0-05" => parameter number 5 of programming level 0
For example: "2-08" => parameter number 8 of programming level 2

8.2. Overview of the programming level

The parameters of the panel meter are organized in different programming levels. According to the design of the panel meter there are several programming levels available.

P-00: Programming level for configuration of the panel meter

The configuration is used to adapt the absolute encoder and the panel meter.

P-02: Programming level for the alarms

This programming level is used to programm all settings for the alarm outputs.

P-03: Programming level for the analog output

This programming level is used to programm all settings of the analog output.

P-04: Programming level of the serial interface

This programming level is used to programm the address and baud rate of the serial interace.

8.3. Programming level for configuration P-00

Para- m.	Description	Setting range	Default value
0-00	Counter modes	0 .. 24	0
	0 -> Incremental A 90° B x 4		
	1 -> Incremental A 90° B x 2		
	2 -> Incremental A 90° B x 1		
	3 -> Pulse counter UP A + direction B		
	4 -> Pulse counter DOWN A + direction B		
	5 -> Pulse counter A		
	6 -> Adder counter A + counter B		
	7 -> Difference counter A - counter B		
	8 -> Ratio counter A/B		
	9 -> Percent difference (A-B)/Ax100.0		
	10 -> Percent difference (B-A)/Ax100.0		
	Frequency-/Rotation measurement modes		
	11 -> Frequency-/Rotation meter A autoranging		
	12 -> Frequency-/Rotation meter A resolution 0,1 Hz		
	13 -> Frequency-/Rotation meter A resolution 1 Hz / rotation per sec.		
	14 -> Frequency-/Rotation meter A resolution 1 Hz / rotation per min.		
	15 -> Frequency-/Rotation meter A resolution 1 Hz / rotation per hour		
	16 -> Frequency-/Rotation meter A + B resolution 1 Hz		
	17 -> Frequency-/Rotation meter A - B resolution 1 Hz		
	18 -> Frequency-/Rotation meter A/B range 0,001 .. 999,999		
	19 -> Frequency-/Rotation meter (A-B)/Ax100.0 range -9999,9 .. 0 .. +100,0 %		
	20 -> Frequency-/Rotation meter (B-A)/Ax100.0 range -100,0 .. 0 .. +99999,9 %		
	Time meter modes		
21 -> Cycle duration meter autoranging 0,0001 .. 999999 s			
22 -> Pulse duration meter autoranging. 0,0001 .. 999999 s			
23 -> Time meter auto. 0,0001 .. 999999 s			
24 -> Time meter 00,00,00 .. 99,59,59 h			

8. Procedure of programming

Para- m.	Description	Setting range	Default value
0-01	Input level / Input logic 0 -> NPN 1 -> 5 V, PNP 2 -> 12 V, PNP 3 -> 24 V, PNP	0 .. 3	0
0-02	Filter input A and B 0 -> filter off 1 -> filter on (approx. 25 Hz)	0 .. 1	0
0-03	Time-Out 0 -> 100 s 1 -> 10 s 2 -> 2 s 3 -> 1 s 4 -> 0,2 s	0 .. 4	3
0-04	Data buffering 0 -> data buffer off 1 -> data buffer on	0 .. 1	0
0-05	Programmable decimal points 0 -> XXXXXX 1 -> XXXXX.X 2 -> XXXX.XX 3 -> XXX.XXX 4 -> XX.XXXX 5 -> X.XXXXX	0 .. 5	0
0-06	Data source of the display 0 -> Current measured value 1 -> MAX value 2 -> MIN value 3 -> Hold value (latch)	0 .. 3	0
0-07	Offset value	-99999 .. 999999	0
0-08	Scaling factor	0.00001 .. 9.99999	1.00000
0-09	Reset time of the MIN/MAX value 0 -> No automatically reset X -> Reset time in seconds	0 .. 100	0

8. Procedure of programming

Para- m.	Description	Setting range	Default value
0-10	Function of digital user input 1 0 -> No function 1 -> Reset MIN/MAX value 2 -> Manual reset of alarms 3 -> Hold function (Latch) 4 -> Display test 5 -> Display current measured value 6 -> Display MAX value 7 -> Display MIN value 8 -> start single serial transmission	0 .. 8	0
0-11	Function of digital user input 2 0 -> No function 1 -> Reset MIN/MAX value 2 -> Manual reset of alarms 3 -> Hold function (Latch) 4 -> Display test 5 -> Display current measured value 6 -> Display MAX value 7 -> Display MIN value 8 -> start single serial transmission	0 .. 8	0
0-12	Function of push button "*" 0 -> No function 1 -> Reset MIN/MAX value 2 -> Manual reset of alarm 3 -> Resetting the counter 4 -> start single serial transmission	0 .. 4	0
0-13	Function of pushbutton "-" 0 -> No function 1 -> Display current measured value 2 -> Display MAX value 3 -> Display MIN value 4 -> Display hold value 5 -> Display/change alarm point 1 6 -> Display/change alarm point 2	0 .. 6	0
0-14	Function of pushbutton "+" 0 -> No function 1 -> Display current measured value 2 -> Display MAX value 3 -> Display MIN value 4 -> Display hold value 5 -> Display/change alarm point 1 6 -> Display/change alarm point 2	0 .. 6	0
0-15	Access-code	0 .. 999	0
0End	Leaving programming level 0		



8.4. Programming level of alarm output P-02

Param.	Description	Setting range	Default value
2-00	Alarm output 1, data source 0 -> Alarm 1 off 1 -> Alarm 1 to current measured value 2 -> Alarm 1 to maximum value 3 -> Alarm 1 to minimum value 4 -> Alarm 1 to hold value	0 .. 4	0
2-01	Alarm output 1, high or low 0 -> Contact closed by low limit 1 -> Contact closed by high limit 2 -> Contact open by low limit 3 -> Contact open by high limit	0 .. 3	0
2-02	Alarm output 1, alarm point	-99999 .. 999999	0
2-03	Alarm output 1, hysteresis	1 .. 1000	1
2-04	Alarm output 1, release delay time in seconds	0 .. 60	0
2-05	Alarm output 1, operate delay time in seconds	0 .. 60	0
2-06	Alarm output 2, data source 0 -> Alarm 2, off 1 -> Alarm 2 to current measured value 2 -> Alarm 2 to maximum value 3 -> Alarm 2 to minimum value 4 -> Alarm 2 to hold value	0 .. 4	0
2-07	Alarm output 2, high or low 0 -> Contact closed by low limit 1 -> Contact closed by high limit 2 -> Contact open by low limit 3 -> Contact open by high limit	0 .. 3	0
2-08	Alarm output 2, alarm point	-99999 .. 999999	0
2-09	Alarm output 2, hysteresis	1 .. 1000	1
2-10	Alarm output 2, release delay time in seconds	0 .. 60	0
2-11	Alarm output 2, operate delay time in seconds	0 .. 60	0
2End	Leave programming level P-02		

Manual alarm reset

In dependence of programming the digital inputs and the functional pushbutton  is the alarm output latched or not latched.

Alarm output latched:

- If the digital input 1, 2 (parameter 0-11 and 0-12) or the functional pushbutton  (parameter 0-13) is programmed to manual alarm reset
- Reset the latched alarm output by activate the digital inputs or press the functional pushbutton 



Alarm output not latched:

- If the digital inputs and the functional pushbutton  are not programmed to manual alarm reset

Display and edit the alarm values 1, 2

- Inside the programmig routine, which is reached over the enter code. During the programming routine no measurement is taken.

Display and edit the alarm value 1 and 2

- Outside the programming routine by pressing the pushbutton  or  during normal measurement are taken.

The edition is end when pressing the pushbutton . Therefore the alarm value will be up to date.

8.4.2. Alarm high setpoint

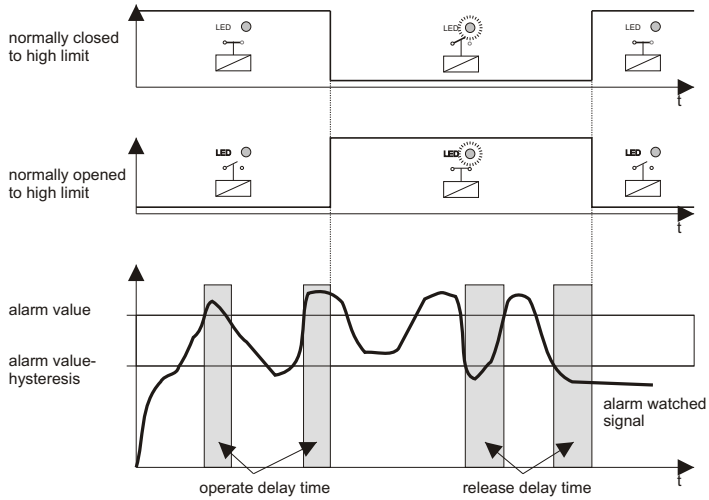

8.4.3. Alarm low setpoint

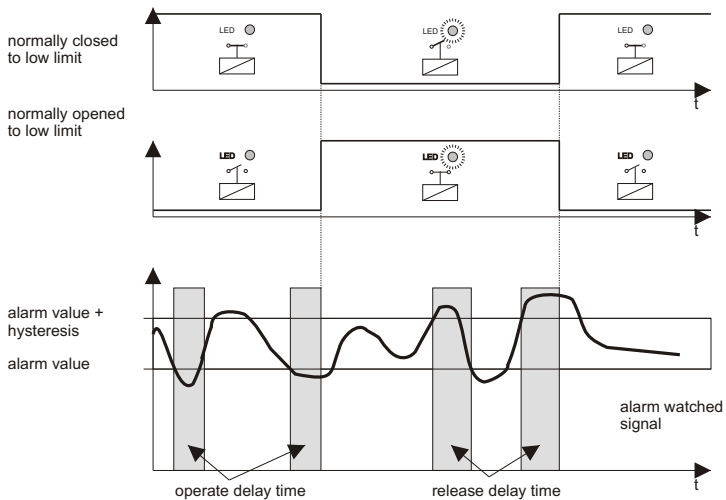

8.5. Programming level of analog output P-03

The parameters of this programming level P-03 exists only by instruments with the option “analog output”.

Para- m.	Description	Seeting range	Default value
3-00	Analog Output, data source 0 -> Value of current measured signal 1 -> MAX value to analog output 2 -> MIN value to analog output 3 -> Hold value to analog output	0 .. 3	0
3-01	Analog Output, configuration 0 -> 0 to 10 V 1 -> 2 to 10 V 2 -> 0 to 20 mA 3 -> 4 to 20 mA	0 .. 3	0
3-02	Display value for minimal analog output signal	-99999 .. 999999	0
3-03	Display value for maximal analog output signal	-99999 .. 999999	4095
3End	Leave programming level P-03		

User considerations !

Parameter 0-00 (11) Mode: Frequency-/Rotation meter autoranging

It is only possible to edit the display value for the minimal analog output signal (parameter 3-02) and for the maximal analog output value (parameter 3-03) in the rang 0.0 Hz to 99999.9 Hz.

Parameter 0-00 (21) Mode: Cycle duration meter

Parameter 0-00 (22) Mode: Pulse duration meter

Parameter 0-00 (23) Mode: Time meter (Start/Stop)



It is only possible to edit the display value for the minimal analog output signal (parameter 3-02) and for the maximal analog output value (parameter 3-03) in the rang 0 sec to 999999 sec.

8.5.1. Scaling of the analog output

The scaling of the analog output range can be programmed with the parameter 3-02 and 3-03. Any value between -99999 and 999999 can be set to minimal and maximal analog output signal.

Data sources of the analog output:

- Value of current measured signal
- Maximum value
- Minimum value
- Hold value

8.5.2. Analog output at overflow and underflow

Output signal	Output value Overflow	Output value Underflow
Voltage 0 to 10 V	10 V	0 V
Voltage 2 to 10 V	10 V	2 V
Current 0 to 20 mA	20 mA	0 mA
Current 4 to 20 mA	20 mA	4 mA

8.6. Programming level of serial interface P-04

The parameters of this programming level P-04 exists only by panel meters with the option serial interface. The interface moduls are bidirectional, isolated of the further electronic and works at the slave mode.

Para-m.	Description	Setting range	Default values
4-00	Interface address	0 .. 31	1
4-01	Interface baud rate 0 -> : 300 baud 1 -> : 600 baud 2 -> : 1200 baud 3 -> : 2400 baud 4 -> : 4800 baud 5 -> : 9600 baud 6 -> : 19200 baud	0 .. 6	6
4-02	Transmission-Mode 0 -> PC-Mode 1 -> Terminal-Mode timer controlled 2 -> Terminal-Mode button/input controlled	0 .. 2	0
4-03	Sendrate in sec. 0 -> permanent transmission	0 .. 3600	0
4-04	Data source for serial interface 0 -> Value of encoder 1 -> MAX value 2 -> MIN value 3 -> Hold value	0 .. 3	0
4-05	Handshake for option RS 232 0 -> without handshake 1 -> with handshake	0 .. 1	0
4End	Leav programming level P-04		

The panel meter can be controlled completely with the serial interface. That means the panel meter can initialized of a host (unit name, revision number). It can be adjust all parameters and it can be read all measured values resp. all values of the parameters.

8.6.1. Transmission Mode

PC-Mode

In PC-Mode a single transmission is started with a special command from the PC. A complete list of all possible commands is available as additional manual.

8.7. Programming quick reference

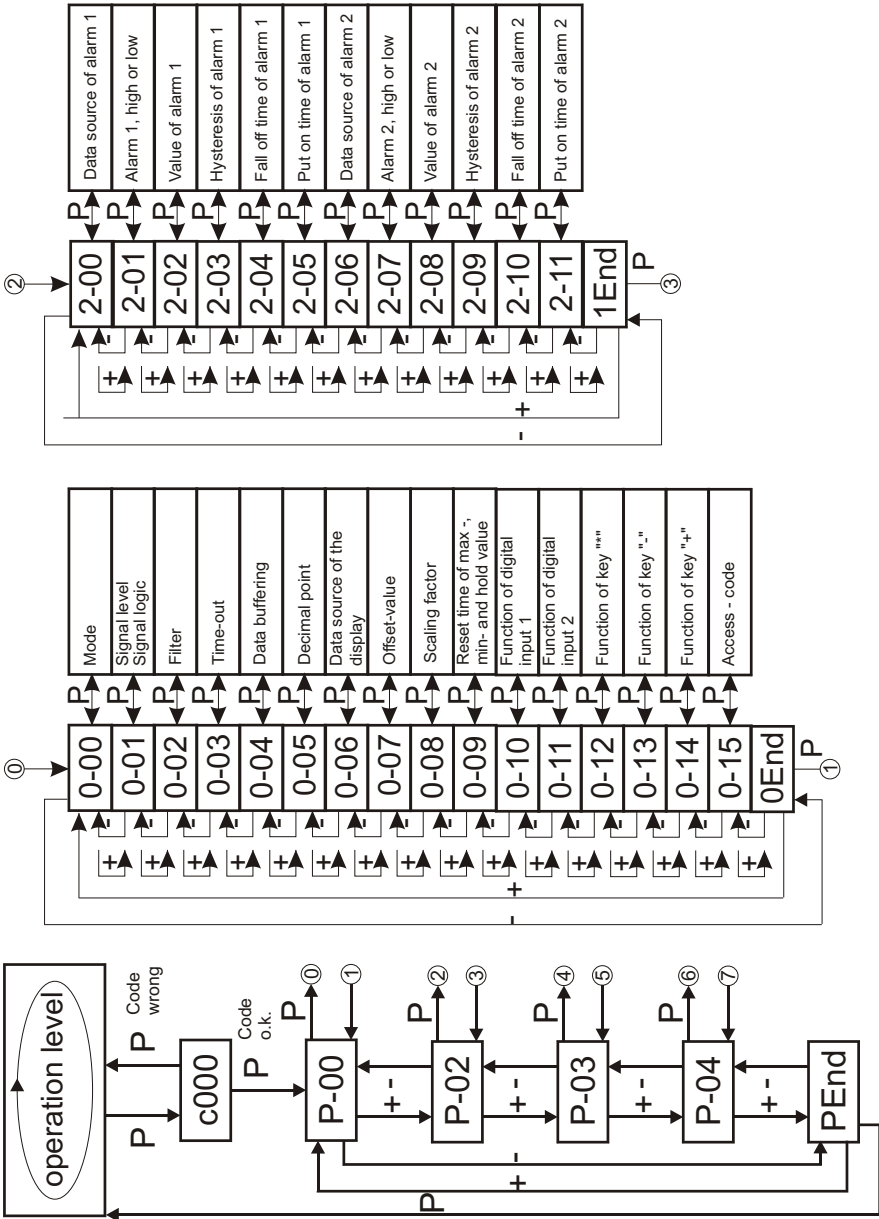

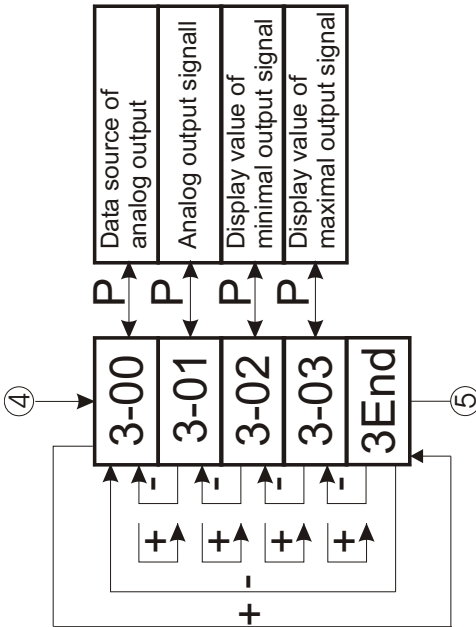
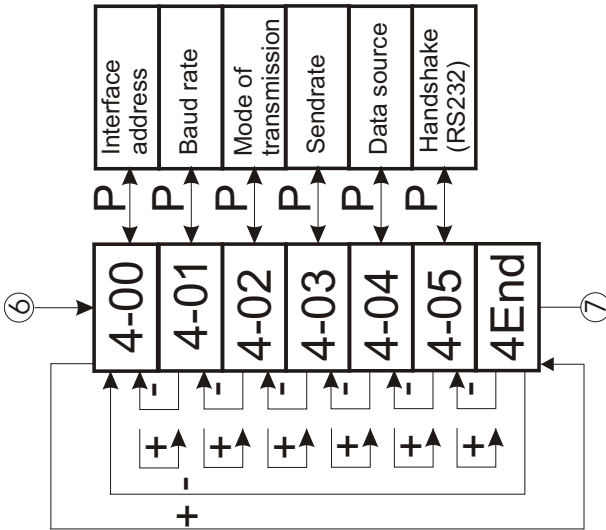

description	
P	- pressing the button
+	- pressing the button
-	- pressing the button

9. Description of modes

9.1. Counter modes

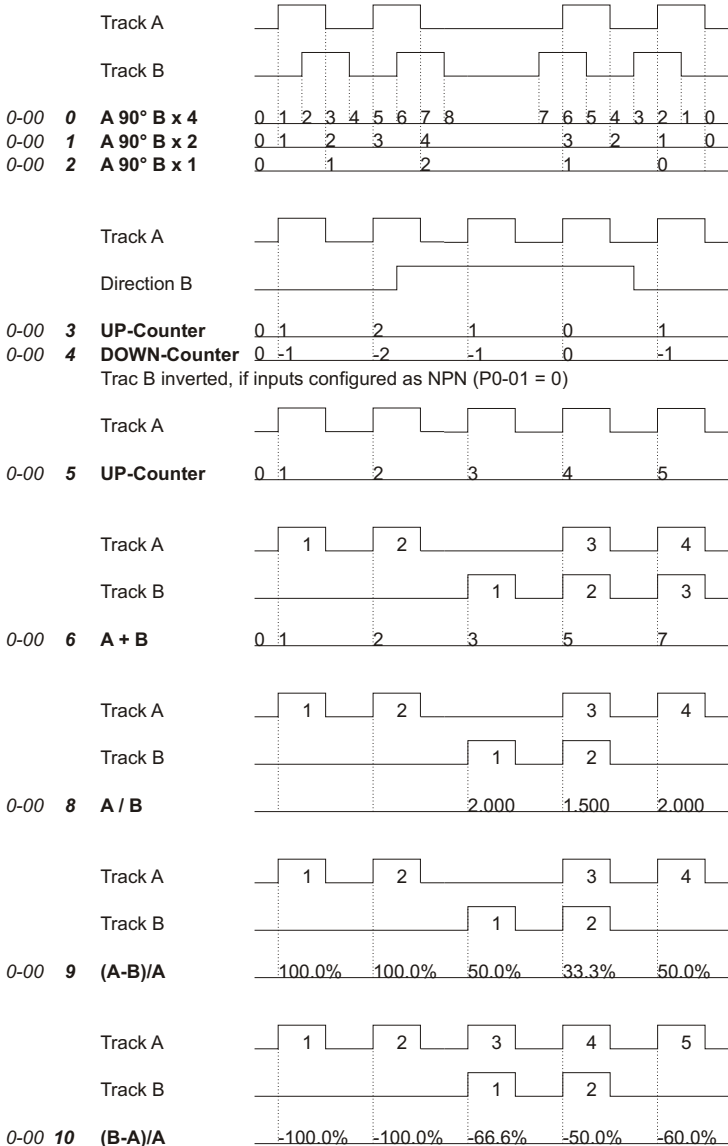

9.2. Frequency-/Rotation speed meter modes

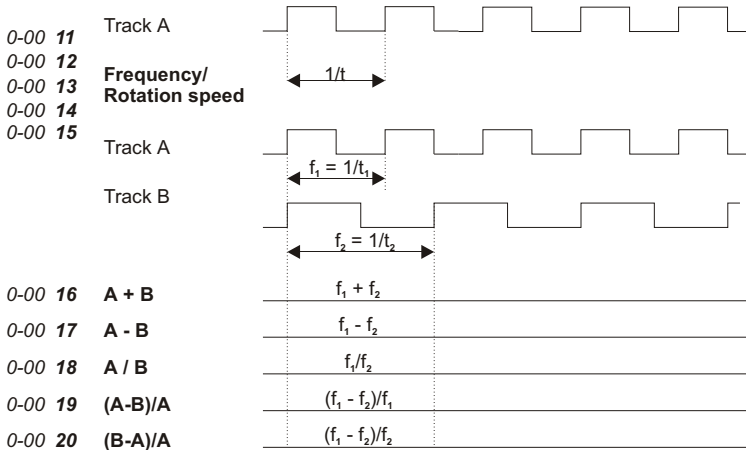

9.2.1. Considerations for use rotation speed meter

The counter CM 9001 decrees the fix scaling factor 60 resp. 3600 in the modes rotation per minute (parameter 0-00 at 14) and the mode rotation per hour (parameter 0-00 at 15). This means that one signal impuls per rotation at input A corresponds to the display rotation per min resp. rotation per hour.

If there are more impulses per rotation at input A, the user can do a adjustment with the scaling factor (parameter 0-08).

$$\text{Scaling factor} = \frac{1}{\text{number of impulse/rotation}}$$

9.3. Time meter modes

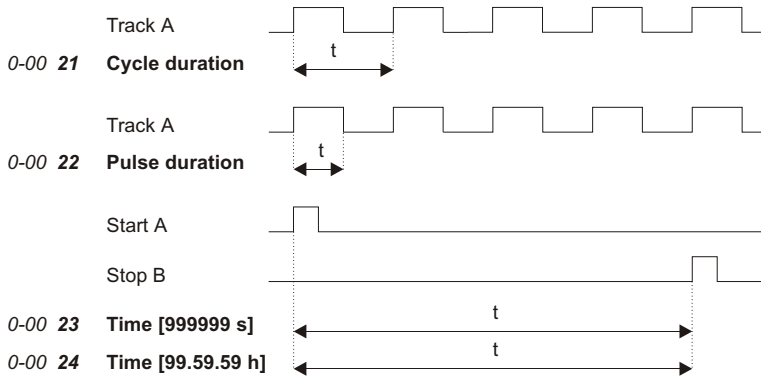

9.4. Scaling factor and offset value

The scaling of the display range is matched by using the scaling factor (parameter 0-08) and the offset value (parameter 0-07). The calculation of the display looks like below:

$$\text{Display} = \text{Measured value} \times \text{Scaling factor} + \text{Offset value}$$

The calculation of the offset value is carry out after the calculation of the scaling factor.

The overflow or underflow becomes active, if the displayed value is greater than 999999 or smaller than -99999.

- When **overflow** is activ the display shows “nnnnnn”
- When **underflow** is active the display shows “uuuuuu”

9.4.1. Tabulation

Parameter 0-00	Data buffer 0-04	Decimal point 0-05	Offset 0-07	Scaling 0-08	Time-Out 0-03
0 to 7	yes	yes	yes	yes	no
8 to 10	yes	no	no	no	no
11 to 12	no	11 no // 12 yes	no	11 no // 12 yes	yes
13 to 17	no	yes	no	yes	yes
18 to 20	no	no	no	no	yes
21 to 22	no	no	no	no	no
23 to 24	yes	no	no	no	no

9.5. Time-Out

The value of time-out (parameter 0-03) is the time, which must pass away between the last recorded impuls and the display value zero. The minimal measured frequency is specified through this, for example 1 sec corresponds the minimal measured frequency > 1 Hz.

10. Input ports

The connection 16 to 19 are signal inputs for the several modes. The input level (5V resp. TTL, 12V, 24V) and the input logic (NPN, PNP) can be programmed in the parameter 0-01.

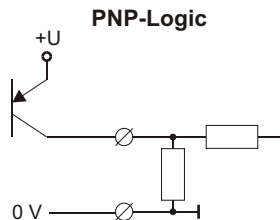
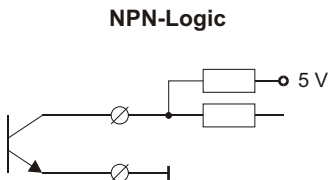

10.1. Input filter

The signal inputs A and B decrease an input filter (parameter 0-02). The filter is programmable for the modes 0 to 10 and 21 to 24.

Activating the 25 Hz-input filter

- program the parameter 0-02 to 1

11. Software functions

11.1. Data buffering

The panel meter decreases a data buffering. The data buffering can be switched on with parameter 0-04 for the modes 0 to 10 and 23 to 24. At power fail, the last displayed value is stored and is available at a new power on.

Activating the data buffer

- program the parameter 0-04 to 1



11.2. MIN/MAX value detection

The panel meter includes a MIN/MAX value detection. The maximum and minimum value can be displayed with the frontal push buttons or the digital user inputs. Besides the maximum and minimum value can be controlled of the alarm output or can be used as the data source for the analog output

Reset the minimum and maximum values:

- Automatically by the programmed memory reset time (parameter 0-09)
- By activating the digital inputs 1 or 2 (parameter 0-10 and 0-11)
- By pressing the functional pushbutton  (parameter 0-12)
- By leaving the programming routine

Display the minimum and maximum value

- By programming as data source of the display (parameter 0-06)
- By activating the digital input 1 or 2 (parameter 0-10 and 0-11)
- By pressing the pushbutton  or  (parameter 0-14 and 0-13)

Indication of the displayed minimum and maximum value

- LED 3 lights red => minimum value is displayed
- LED 3 lights green => maximum value is displayed

11.3. Hold function

When activating the hold function the value of the data source, which is programmed in parameter 0-06, is taken over into the hold memory. If the hold function is not active the hold value is the same as the value of the data source, which is programmed in parameter 0-06.



Activating the hold function by:

- Digital input 1 (parameter 0-10)
- Digital input 2 (parameter 0-11)

Reset the hold value

- By leaving the programming routine

Display the hold value by

- Programming as data source of the display (parameter 0-06)
- Pressing the pushbutton  or  (parameter 0-13 and 0-14)

The hold value can:

- Show on display
- Watched by alarm output
- Set to the analog output

11.4. Display test

When activating the display test all segments of the display are light on. The display shows “8.8.8.8.8.8.”

Activating the display test by:

- Digital input 1 (parameter 0-11)
- Digital input 2 (parameter 0-12)

11.5. Main reset

The main reset is performed by pressing a key combination at the front of the panel meter. By doing this all parameters are setting to the default value. During the main reset the display shows “Init.”.

Perform the main reset by

Pressing the pushbuttons  ,  and  at the same time during 10 seconds.

12. Technical Specifications

12.1. Electrical datas

Counter incremental	: counter steps 24 bit
Count frequency	: max. 4,5 kHz
filter active	: max. 25 Hz
UP/DOWN-counter + direction	: counter steps 24 bit
Count frequency	: max. 10 kHz
filter active	: max. 25 Hz
Pulse counter	: counter steps 24 Bit
Count frequency	: max. 10 kHz
filter active	: max. 25 Hz
Frequency/Rotation speed	
Accuracy	: < 0,01 %
1-channel mode	: max. 20 kHz
filter active	: max. 25 Hz
2-channel mode (f.e. A/B)	: max. 10 kHz
filter active	: max. 25 Hz
Resolution	: 0.01 Hz auto, 0.1 Hz, 1 Hz
Cycle duration	: 0.0001 s .. 999999 s auto.
Accuracy	: < 0,02 %
Pulse duration	: 0.0001 s .. 999999 s auto.
Accuracy	: < 0,02 %
Time meter	: 0.0001 s .. 999999 s or 00.00.00 .. 99.59.59 h
Accuracy	: < 0,02 %
Update rate	
Counter modes	: 60 ms
Frequency-/Time meter	: 100 ms
Input filter for signal A and B	: 25 Hz programmable
Data buffering	: > 10 years(NOVRAM)
Signal inputs	: 4 (inputs A, B, reset, gate)
Logic	: PNP, NPN
Signal level 5 V	: low < 0,8 V, high > 4 V
Signal level 12 V	: low < 3 V, high > 8 V
Signal level 24 V	: low < 6 V, high > 16 V
Digital user inputs	: 10 k to +5 V
Logic	: NPN, max. 30 V
Signal level	: L-Pegel < 0,8 V : H-Pegel > 2,8 V

Alarm outputs	: 2 relays (programmable as opened contact or closed contact)
Signaling	: 2 LEDs at the front
Switch voltage	: 250 V AC / 250 V DC
Switch current	: 5 A AC / 5 A DC
Switch power	: 750 VA / 100 W
Option analog output	: resolution 16 bit
Accuracy	: $\pm 0,2 \%$ of final value
Nonlinearity	: $\pm 0,012 \%$
Voltage	: 0/2 - 10 V, max. 10 mA
Current	: 0/4 - 20 mA, max. 500
Isolation voltage	: 3 kV / 1 min
Option interfaces	: RS 485, RS 232, TTY
Protocol	: DIN 66 019 / ISO 1745
Baud rate	: 300, 1200, 2400, 4800, 9600, 19200
Data format	: 1 Start, 8 Data, N-Parity, 1 Stop
Isolation voltage	: 1,6 kV / 1 min
Power supply AC	: 95 .. 250 V AC
Power consumption	: approx. 9 VA
Isolation voltage	: 2,5 kV / 1 min
Option power supply DC	: 18 .. 36 V DC
Power consumption	: approx. 70 mA
Isolation voltage	: 500 V / 1 min
Accessory power supply (only at AC)	: 24 V DC $\pm 10 \%$, max. 125 mA
Isolation voltage	: 500 V / 1 min

12.2. Mechanical datas

Display	: 6 decades, 8 mm, red
	: decimal point programmable
	: preliminary zero suppression
	: - sign at negative values
Operation, keyboard design	: front membrane with push buttons
Case	: rail mounting DIN EN 50022
Dimensions (B x H x T)	: 67,5 x 75 x 105 mm
Weight	: approx. 400 g
Connection	: plug-in screw terminal

12.3. Environmental conditions

Operating temperature	: 0 .. 50 °C
Storage temperature	: -20 .. 70 °C
Humidity	: < 80 %, not-condensing
Protection	: protection class II
Front protection	: IP 40
	: connectors IP 20
Field of application	: class 2
	: overvoltage protection II
CE	: in conform with 89/336/EWG
	: NSR 73/23/EWG

13. Ordering information

CM 9001 -				
				Reserve
				Front design
			0	No logo
				Power supply
		0	5 V DC, +/- 10 %, isolated	
		1	12 V DC, +/- 10 %, isolated	
		2	18 .. 36 V DC, isolated	
				Option interface RS 485
		0	No interface	
		1	RS 485	

ERMA - Electronic GmbH
Max-Eyth-Str. 8
D-78194 Immendingen

Telefon (+49 7462) 2000-0
Fax (+49 7462) 2000-29
email info@erma-electronic.com
Web www.erma-electronic.com

